

public works
& infrastructure

Department:
Public Works and Infrastructure
REPUBLIC OF SOUTH AFRICA

SASSA: KHAYELITSHA 2

BID / TENDER NO. CPTL36/21



Notice and Invitation to Bid: PA-04 (LS)
PA-04 (LS): NOTICE AND INVITATION TO BID

THE DEPARTMENT OF PUBLIC WORKS INVITES BIDDERS FOR PROVISION OF:

Property description:	OPEN TENDER PROCEDURE TO PROCURE NEW OFFICE ACCOMMODATION FOR SASSA: KHAYELITSHA OFFICE 2: FOR A PERIOD OF FIVE (5) YEARS: LETTABLE GUIDELINE: 964.45 m², 2 LOCK UP GARAGES, 9 UNDER COVER AND SECURED PARKING BAYS
-----------------------	---

Bid no:	CPTL36/21		
Advertising date:	25 February 2022	Closing date:	18 March 2022
Closing time:	11H00	Validity period:	60 days

Only bidders who are responsive to the following responsiveness criteria are eligible to submit bids:

<input checked="" type="checkbox"/>	Tender offer must be properly received on the tender closing date and time specified on the invitation, fully completed and signed in ink (All as per Standard Conditions of Tender).
<input checked="" type="checkbox"/>	The (DPW-08 (LS)): Bid offer must be clearly completed by the bidder, with clear specification of the financial offer in terms of rental and tenant installation allowance offered by bidder and the bid documents should be duly signed in ink, by the bidder. The offer should be submitted as per the bid questionnaire which forms part of the bid documents.
<input checked="" type="checkbox"/>	The building must be within the geographic boundaries specified in the bid documents
<input checked="" type="checkbox"/>	Submission of applicable (PA-15.1, PA-15.2, PA-15.3): Resolution by the Legal Entity, or consortium / joint venture, authorising a dedicated person(s) to sign documents on behalf of the firm / consortium / joint venture.
<input checked="" type="checkbox"/>	Submission of (PA-11): Declaration of Interest and Bidder's Past Supply Chain Management Practices.
<input checked="" type="checkbox"/>	Submission of (PA-29): Certificate of Independent Bid Determination.
<input checked="" type="checkbox"/>	Submission of other compulsory returnable schedules / documents as per (PA-09 (LS)): List of returnable documents.
<input checked="" type="checkbox"/>	If the bidder is an agent, a copy of the mandate from the owner must be submitted with the bid documents or in case of a prospective buyer the signed purchase agreement must be submitted.
<input checked="" type="checkbox"/>	Registration on National Treasury's Central Supplier Database (CSD). Provide Supplier Registration Number on the Form of offer (DPW08.01)
<input checked="" type="checkbox"/>	Compliance with Pre-qualification criteria for Preferential Procurement
<input checked="" type="checkbox"/>	Use of correction fluid is prohibited
<input checked="" type="checkbox"/>	Submission of a copy of Tax Clearance Certificate or SARS pin.
<input checked="" type="checkbox"/>	PA-40: Declaration of designated groups for preferential procurement
<input checked="" type="checkbox"/>	Submission of BBBEE Certificate in terms of the property sector code. The said certificate must be that of the owner or the prospective buyer of the building.
<input type="checkbox"/>	Price breakdown of basic rental tariff and all other costs i.e. operating costs, tenant installations, refurbishment costs must be provided on a separate attachment and submitted with the bid to correspond with DPW08.01 form of offer.



Notice and Invitation to Bid: PA-04 (LS)

Tenderer must comply with the Pre-qualification criteria for Preferential Procurement listed below

<input checked="" type="checkbox"/>	<p>Category A - refers to segment where a property is owned by an enterprise(s)/ individual(s) which are not less than:</p> <ul style="list-style-type: none"> a. 51% Black-ownership b. 51% Black-management c. 51% Black controlled ; and d. With a B-BBEE certificate status level 4 or above assessed in terms of the Property Sector codes
<input checked="" type="checkbox"/>	<p>Category B – refers to a segment where a property is owned by an enterprise(s)/ individual(s) which have not less than :</p> <ul style="list-style-type: none"> a. 20% Black- ownership; b. 20% Black management c. 20% Black Controlled ; and d. With a B-BBEE certificate status level 4 or above assessed in terms of the Property Sector Codes
<input checked="" type="checkbox"/>	<p>Category C – refers to a segment where a property is owned by an enterprise(s)/ individual(s) with less than</p> <ul style="list-style-type: none"> a. 20% Black- ownership; b. 20% Black management c. 20% Black Controlled ; and d. With a B-BBEE certificate status level 4 or above assessed in terms of the Property Sector Codes
<input checked="" type="checkbox"/>	<p>Category D – refers to property funds listed on the Stock Exchange :</p> <ul style="list-style-type: none"> a. That qualify as listed property funds or real estate investment trusts (REITS); b. That have ownership by black individuals or black entities of more than 10% but less than 51% ; and c. That are managed by property asset management entities with not less than 51% Black ownership ; 51% Black management and 51% Black control

This bid will be evaluated according to the preferential procurement model in the PPPFA: *(Tick applicable preference point scoring system)*

<input checked="" type="checkbox"/> 80/20 Preference points scoring system	<input type="checkbox"/> 90/10 Preference points scoring system	<input type="checkbox"/> Either 80/20 or 90/10 Preference points scoring system
---	--	--

Price:	
Price:	80 % of 100
Total must equal:	100%

Functionality:



Notice and Invitation to Bid: PA-04 (LS)

Functionality:	
Functionality:	100 %
Minimum Functionality Score	50 %
Total must equal:	100%

Functionality criteria:	Weighting factor:
<p>LOCALITY (to be physically verified by the Department and end user Department)</p> <p>Area: The premises (building or land) must be Khayelitsha, preferably in close proximity to the public transport. Preferred Makaza area and surrounds.</p> <p>If the building or land is within 500 meters from Makaza area and surrounds. – Score 5/5</p> <p>If the building of land is within 1 km from Makaza area and surrounds. – Score 4/5</p> <p>If the building or land is within 1,3 km from Makaza area and surrounds. – Score 3/5</p> <p>If the building or land is within 1,5 km from Makaza area and surrounds. – Score 2/5</p> <p>If the building or land is within 2 km from Makaza area and surrounds. – Score 1/5</p> <p>If building or land is more than 2 km from Makaza area the bid will not be evaluated any further.</p> <p>The bidder must attach a locality map depicting the location of the building or land offered and distances from the said point of reference, Makaza area.</p>	30



Notice and Invitation to Bid: PA-04 (LS)

<p>SUITABILITY: The actual space required (964.45 m² office space, 2 lockup garages, 9 under cover and secured parking bays). Zoning Certificate confirming office use MUST be attached.</p> <p>NB: The accommodation MUST be preferably on GROUND FLOOR if on multiple floor it must be on continuous floors. Proposed layout plan and site plan MUST be attached. An existing building to be available within 4-6 months after the date of award.</p> <p>An existing open building without or with internal dry wall partitioning which can easily be reconfigured to suit the required space planning and layout and not in a sectional title scheme. All the required parking to be provided onsite, a cellular building not to be shared but single tenanted. – Score 5/5</p> <p>An existing open building without or with internal dry wall partitioning which can easily be reconfigured to suit the required space planning and layout and not in a sectional title scheme. All the required parking to be provided onsite, a cellular or multi-tenanted building. – Score 4/5</p> <p>An existing building with or without solid internal walls not easy to reconfigure to suit the required space planning and layout and not in a sectional title scheme, All the required parking to be provided onsite, cellular or multi-tenanted building – Score 3/5</p> <p>An existing building with or without solid internal solid walls not easy to reconfigure to suit the required space planning and layout with not all parking achievable onsite - Score: 2/5</p> <p style="text-align: center;">OR</p> <p>In the event that there is no suitable existing building offered, only then will the vacant land be considered.</p> <p>Vacant site requiring development already zoned to suit the intended use and fully serviced – Score 5/5</p> <p>Vacant site requiring development not zoned to the intended use fully serviced will not be considered at all in exception of the client approval</p> <p>NB: New building to be designed to the occupation requirements of the department "Fit for purpose" and constructed for occupation on a predetermined date including the tenant requirements. The building must be ready for occupation within 12 months after the date of award. Bidder to submit proposed preliminary designs and layout building plans in line with the current Land Use Management System (LUMS) of the local municipality as per the attached space norm documents and zoning certificate Bidders will not be evaluated if they do not comply with Suitability (required space).</p>	<p>30</p>
<p>Accessibility for Public: The building or site must be easily accessible by the following modes of transport namely taxis and buses.</p> <p>If the building or site is accessible by two of the above modes : 5/5 If the building or site is accessible by one of the above modes : 2/5</p> <p>The bidder must clearly demonstrate in writing as to how the offered building or land can be accessed by means of the set criteria</p>	<p>40</p>
<p>THE BIDDER MUST OBTAIN A SCORE IN ALL CATEGORIES AND ACHIEVE A MINIMUM OF 50%. IF A BIDDER FAILS TO OBTAIN SCORES IN ALL CATEGORIES THE BID WILL BE INELIGIBLE TO PROCEED TO THE NEXT STAGE, EVEN IF THE MINIMUM SCORE OF 50% IS ACHIEVED.</p>	
<p>Total</p>	<p>100 Points</p>



Notice and Invitation to Bid: PA-04 (LS)

Subject to sub-regulation 6(2) and /or 7 (2), points must be awarded to a tenderer for attaining B-BBEE status level contributor in accordance with the table below:

B-BBEE Status Level of Contributor	Number of Points (90/10 system)	Number of Points (80/20 system)
1	10	20
2	9	18
3	6	14
4	5	12
5	4	8
6	3	6
7	2	4
8	1	2
Non-compliant contributor	0	0

- A maximum of 10/20 points may be allocated in accordance with sub-regulation 7(2) and 6(2) respectively of the PPPFA Regulations of 2017.
- The points scored by a tenderer in respect of the level of BBEE contribution contemplated in sub regulation 6 (2) and 7(2) must be added to the points scored for price as calculated in accordance with sub regulation 6 (1) and 7 (1) respectively
- Subject to regulation 7, the contract must be awarded to the tenderer who scores the highest total number of points.
- A contract may be awarded to a tenderer that did not score the highest total number of points, only in accordance with section 2 (1) (f) of the Act.

1. COLLECTION OF BID DOCUMENTS:

- Bid documents may be collected during working hours at the following address. **Room 941, Customs House Building Lower Heerengracht, Foreshore, Cape Town.**
- A non-refundable bid deposit of **R 200.00** is payable, (Cash only) is required on collection of the bid documents.
- A non- **compulsory** virtual meeting with representatives of the Department of Public Works will take place on zoom on -starting at.

Join Zoom Meeting

2. ENQUIRIES RELATED TO BID DOCUMENTS MAY BE ADDRESSED TO:

Contact person:	Cirillo Celento	Telephone no:	021 402 2156
Cell no:		Fax no:	
E-mail:	Cirillo.celento@dpw.gov.za		

3. DEPOSIT / RETURN OF BID DOCUMENTS:

- 3.1. Telegraphic, telephonic, telex, facsimile, electronic and / or late tenders will not be accepted.
- 3.2. Requirements for sealing, addressing, delivery, opening and assessment of tenders are stated in the bid document.



Notice and Invitation to Bid: PA-04 (LS)

3.3. All tenders must be submitted on the official forms – (not to be re-typed).

BID DOCUMENTS MAY BE POSTED TO: THE DIRECTOR -GENERAL DEPARTMENT OF PUBLIC WORKS AND INFRASTRUCTURE PRIVATE BAG X9027 <i>Cape Town</i> <i>8000</i> ATTENTION: PROCUREMENT SECTION: ROOM 941 <i>POSTED TENDERS MUST BE RECEIVED PRIOR CLOSING DATE AND TIME AT 11H00 BY THE DEPARTMENT</i>	OR	DEPOSITED IN THE TENDER BOX AT: <i>Customs House Building</i> <i>Lower Heerengracht</i> <i>Foreshore</i> <i>Cape Town</i> <i>Ground Floor Entrance</i>
--	----	--

4. COMPILED BY:

C. Celento		24/2/2022
Name of Property Manager	Signature	Date

51.6.9/6

SEAL NO	DESCRIPTION OF ROOM	PROPOSED PU	NORM PER PU	ASSY	REMARKS
	ASSIGNABLE AREA KHAYELITSHA SITE 2				
	MANAGEMENT				
1	MANAGER L1-L2	1	18.00	18.00	
2	ADMINISTRATION	2	8.00	16.00	
3	ADSTATE ACCOUNTANT L2	30	8.00	240.00	
4	RECEPTIONIST	1	12.00	12.00	
5	CLEANER AND DRIVER MESSENGER	2	2.50	5.00	MIN 12M ² 12.5M ² PER MESSENGER
6	CABINETS	17	0.80	13.60	
7	TEA KITCHEN	190	0.05	9.50	MIN 4M ² - MAX 8M ²
8	TEA ROOM	80	0.50	40.00	MIN 12M ² - MAX 40M ²
9	CONFERENCE ROOM	125	1.40	175.00	MIN 30M ² - MAX 175M ²
10	COMMITTEE ROOM	30	1.20	36.00	MIN 30M ²
11	PHOTOCOPI ROOM	1	12.00	12.00	MIN 12M ²
	PUBLIC SERVICE AREA				
12	WAITING AREA	10	10.00	100.00	10M ² PER 100 STAFF
13	COUNTER	1	1.50	1.50	
14	AREA IN FRONT OF COUNTER	1	4.50	4.50	
15	AREA BEHIND COUNTER	1	2.00	2.00	
16	OFFICE BEHIND COUNTER	1	8.00	8.00	
17	BM & D WAITING AREA	2	10.00	20.00	
18	STRONG ROOM	1	12.00	12.00	
	OTHER ACCOMMODATION				
19	ARCHIVES (REGISTRY)	1	12.00	12.00	
20	FIRST AID ROOM	1	12.00	12.00	
	NON ASSIGNABLE AREA (20%)			771.30	
	CIRCULATION, MAINTENANCE, DUTY AND STRUCTURAL SPACE			102.25	
	ADMINISTRATION				
21	GENERAL STORE	2	0.10	0.20	MIN 12M ² TO 14M ² PER STAFF MEMBER
22	ABLUTION FACILITIES	2			
23	MALE	1			
24	FEMALE RESTROOMS	1			
25	PARKING	2			
26	UNDER COVER PARKING	9			
28	LOCK UP GARAGE				
	TOTAL CURBLINE GROSS AREA			834.40	
	TOTAL LETTABLE AREA FOR LEASE PURPOSES			678.77	

COMPILED BY: Parent CHECKED BY: SP
 DATE: 2013-07-02 DATE: 2013/08
 VERIFIED BY: SP DATE: 2013/07/02
 DRAWN BY: Madawen
 DATE: 2013/8/30

CONFIRMED, ACCOMMODATION PARTICULARS AND SPACE NORMS APPLIED

PA-09 (LS): LIST OF RETURNABLE DOCUMENTS

Property description:	OPEN TENDER PROCEDURE TO PROCURE NEW OFFICE ACCOMMODATION FOR SASSA: KHAYELITSHA OFFICE 2: FOR A PERIOD OF FIVE (5) YEARS: LETTABLE GUIDELINE: 964.45 m², 2 LOCK UP GARAGES, 9 UNDER COVER AND SECURED PARKING BAYS		
Property Manager:	C. Celento	Bid / Quote no:	CPTL36/21
Receipt Number:			

1. THE BIDDER MUST COMPLETE THE FOLLOWING RETURNABLE DOCUMENTS:

(Bidders may use the "Returnable document" column to confirm documents have been completed and returned by inserting a tick)

Bid Document Name:	Number of Pages:	Returnable document:
PA-04 (LS): NOTICE AND INVITATION TO BID (Inclusive of Client Needs Assessment , Annexure A and Annexure B)	10 Pages	<input type="checkbox"/>
TCC001: APPLICATION FOR TAX CLEARANCE CERTIFICATE	2 Pages	<input type="checkbox"/>
PA-09 (LS): LIST OF RETURNABLE DOCUMENTS	2 Pages	<input type="checkbox"/>
PA-10 (LS): IMPORTANT CONDITIONS OF BID	1 Pages	<input type="checkbox"/>
PA-11: DECLARATION OF INTEREST	4 Pages	<input type="checkbox"/>
	1 Pages	<input type="checkbox"/>
PA-15.1: RESOLUTION OF BOARD OF DIRECTORS	2 Pages	<input type="checkbox"/>
PA-15.2: RESOLUTION OF BOARD OF DIRECTORS TO ENTER INTO CONSORTIA OR JOINT VENTURES	2 Pages	<input type="checkbox"/>
PA-15.3: SPECIAL RESOLUTION OF CONSORTIA OR JOINT VENTURES	3 Pages	<input type="checkbox"/>
PA-16: PREFERENCE CERTIFICATE	5 Pages	<input type="checkbox"/>
STANDARD LEASE AGREEMENT (DRAFT) initial all pages	26 Pages	<input type="checkbox"/>
DPW-08.1(LS): BID OFFER - OFFICE ACCOMMODATION	4 Pages	<input type="checkbox"/>
DPW-11.1 (LS): SPECIFICATION ON MINIMUM REQUIREMENTS	3 Pages	<input type="checkbox"/>
DPW-12(LS): OCCUPATIONAL HEALTH AND SAFETY ACT CERTIFICATE	1 Pages	<input type="checkbox"/>
	1 Pages	<input type="checkbox"/>
PA-29: CERTIFICATION OF INDEPENDENT BID DETERMINATION	4 Pages	<input type="checkbox"/>
PA-40: DECLARATION OF DESIGNATED GROUPS FOR PREFERENTIAL PROCUREMENT	2 Pages	<input type="checkbox"/>
NATIONAL TREASURY RSA: GOVERNMENT PROCUMENT: GENERAL CONDITIONS OF CONTRACT	15 Pages	<input type="checkbox"/>
CENTRAL SUPPLIER DATABASE TO BE ATTACHED OR NUMBER TO BE PROVIDED ANYWHERE IN THE BID DOCUMENT	Pages	<input type="checkbox"/>
	Pages	<input type="checkbox"/>
	Pages	<input type="checkbox"/>
	Pages	<input type="checkbox"/>
	Pages	<input type="checkbox"/>
	Pages	<input type="checkbox"/>



	Pages	<input type="checkbox"/>
--	-------	--------------------------

Name of Bidder	Signature	Date

PA-10 (LS): IMPORTANT CONDITIONS OF BID

Bid no:	CPTL36/21	Closing date:	18 March 2022
Advertising date:	25 February 2022	Validity period:	60 days

1. Bids that are not accompanied by written proof that the bidder is authorised to offer the accommodation for leasing will not be considered.
2. The only or lowest offer will not necessarily be accepted.
3. The Department of Public Works is the sole adjudicator of the suitability of the accommodation for the purpose for which it is required. The Department's decision in this regard will be final.
4. The Department of Public Works will in no way be responsible for or committed to negotiations that a user department may or might have conducted with a lessor or owner of a building.
5. It is a requirement that the accommodation offered, including all equipment and installations, must comply with the National Building Regulations and the requirements of the Occupational Health and Safety Act, 1993 (Act 85 of 1993), as amended. **A certificate to this effect must be issued.**
6. Drawings/ Architect's plans of the accommodation offered must be submitted. **In this regard it is a prerequisite that bidders should do a preliminary planning on the floor plans in accordance with the norm document.**
7. Lettable areas have to be determined in accordance with the **SAPOA** method for measuring floor areas in office buildings. The offer may not be considered if a certificate by an architect, certifying the area is not submitted.
8. The commencement date from which rental will be payable or the lease shall begin is subject to the approval of the Department of Public Works.
9. The lease agreement and payment of rental will commence from the date of occupancy. Rental will be adjusted on a yearly basis thereafter in accordance with an agreed upon escalation rate starting at the beginning of the second year.
10. No bids sent by facsimile will be accepted.
11. Bidders are welcome to be present at the opening of bids.
12. This annexure is part of the bid documentation and must be signed by the bidder and attached.
13. The bid forms must not be retyped or redrafted but photocopies may be used. Additional offers may be made but only on photocopies of the original documents or on other forms requisitioned. Additional offers are regarded as separate bids and must be treated as such by the bidder. The inclusion of various offers as part of a single submission in one envelope is not allowed. Additional offers must be submitted under separate cover.
14. The successful bidder will be responsible for the cost of alterations necessary to adapt the offered accommodation to the specific needs of the user department in accordance with the norm document and/or specified and minimum requirements.
15. Appended herewith is an example of a **(PA-07): Application for Tax Clearance Certificate** of which an original signed and stamped certificate should be obtained from the SA Revenue Services and submitted together with the completed bid document.
16. Failure to comply with the above-mentioned conditions may invalidate a bid.

BIDDER'S SIGNATURE:

Name of Bidder	Signature	Capacity	Date



SPECIAL CONDITIONS OF BID

1. DOCUMENTS TO BE SUBMITTED

The following documents must accompany the tender documentation. **FAILURE TO SUBMIT WILL INVALIDATE THE BID.**

- 1.1 Certified copy of the founding statement (CK1), if the firm is a Close Corporation.
- 1.2 Articles of Agreement, (CM1) and shareholding certificates endorsed by an auditor if the firm is a Company for the bidding entity. If the property offered is held by the holding company which is not the tendering entity, the shareholding certificates of that holding entity must be submitted as well.
- 1.3 Articles of Association and shareholding certificate, endorsed by an auditor, if the firm as a private company (Pty) Ltd. If the property offered is held by the holding company which is not the tendering entity, the shareholding certificates of that holding entity must be submitted as well.
- 1.4 In the event of the bidder being a public company, a letter from their auditor, certifying their status as a public company and attached thereto, a certified copy of the bidder's Articles of Agreement.
- 1.5 Copy of a joint venture agreement if bidder is a joint venture and / or consortium.
- 1.6 A certified copy of the original building plan approval for the subject property when first developed.
- 1.7 A zoning history printout confirmation from the relevant municipality of the subject property, so as to determine original zoning.
- 1.8 Current zoning of the subject property;
- 1.9 Certificates and ID documents to be submitted must be original certified copies. Copy of a certified copy will not be accepted.

2. MODE OF BID

- 2.1 All forms of this bid shall be duly completed, initialed and signed, including annexures, addendums and specifications all shall be returned with the Bid document as a whole. Bidders are required to return the complete set of documents, failure do to so will lead to disqualification.

3. INSURANCE CLAIMS, ETC.

- 3.1 The Department shall not be liable in any manner in respect of any claims, damages, accidents and injuries to persons, property or rights or any other courses of civil or criminal action that may arise from the carrying out of this contract. The landlord shall insure his / her / their personnel and any plant, machinery or other mechanical or electronic equipment involved in the fulfilment of this contract and shall indemnify The Department against all risks or claims which may arise.

4. PRICE ESCALATION

- 4.1 Maximum escalation rate (percentage) must not exceed 6% per annum.

5. DURATION OF CONTRACT

- 5.1 The contract period is for 05 years.
5.2 **The Department reserves the right to consider the renewal of the lease, without going to an open bidding process.**

6. DISPUTES

- 6.1 In the event that disputes cannot be resolved by internal systems, the disputes will be settled by means of an arbitration.

7. COMMUNICATION

- 7.1. The Department of Public Works will under no circumstances take responsibility if a user department may or might have committed or negotiated with lessors or owners of a building outside its bidding processes.

8. OCCUPATION DATE

- 8.1. The building **MUST** be available for occupation by the Department by no later than **four (04) months** after the award of tender and approved space planning. In the case of a vacant site, the building **MUST** be available for occupation by the Department by no later than **Twelve (12) months** after the award of tender and approved space planning.
- 8.2. Furthermore, a finishing schedule is also required. (**Refers to the DPW-11.1 LS form and the minimum technical requirements**)

9. COMPLIANCE

- 9.1. All required building compliance certificates and maintenance contracts shall be issued to the Department 10 (ten) days before hand-over of the building. Non-compliance will lead to cancellation of the award. Certification must include, not limited to the following:
- Fire, Electrical, Roof, Institute of Plumbing SA, COC, Building Grade Certificate, Area Certificate or floor plans certified by a professional Architect, as well as air quality certificate, Borehole Beetle test.
- 9.2. The accommodation must comply with all existing legislation and regulations applicable to the Built environment.

10. PRICE NEGOTIATION

- 10.1. If the price offered by a bidder scoring the highest points is not market related, the Department may not award the contract to that tenderer. However,

- (a) The Department may -
 - (i) negotiate a market-related price with the tenderer scoring the highest points or cancel the tender;
 - (ii) if the tenderer does not agree to a market-related price, negotiate a market-related price with the tenderer scoring the second highest points or cancel the tender;
 - (iii) if the tenderer scoring the second highest points does not agree to a market-related price, negotiate a market-related price with the tenderer scoring the third highest points or cancel the tender
- (b) If a market-related price is not agreed as envisaged in paragraph (a) (iii), the Department **must** cancel the tender.

11. BUILDING OPERATING COSTS

11.1. The Department will be responsible for the operating costs that relate directly to its own tenancy activities and that, where applicable, are separately metered. The Department is prepared to incur the following operating costs:

- a) Water consumption;
- b) Electricity consumption;
- c) Refuse removal;
- d) Internal security;
- e) Internal cleaning and
- f) Consumable supplies.

11.2. The Department will not be responsible for any other operating costs.

11.3. The Department will not be responsible for the payment of rates and taxes as well as periodic increases thereof.

12. BUILDING MAINTANANCE COSTS

12.1. All maintanance shall be the responsibility of the landlord.

12.2. Other responsibilities between the landlord and the tenant will be stipulated in the lease agreement.

13. TENDERERS MUST NOT USE B-BBEE CERTIFICATES OR SWORN AFFIDAVITS PREPARED ACCORDING TO GENERIC SECTOR CODES, ONLY PROPERTY SECTOR CODES ARE ALLOWED.
14. BIDDERS TO NOTE THAT A GENERAL CODE B-BBEE CERTIFICATE OR SWORN AFFIDAFIT WILL NOT BE ACCEPTED, IT WILL RENDER THE BID NONE RESPONSIVE.

DPW-11.1 (LS): SPECIFICATION ON MINIMUM REQUIREMENTS – OFFICE ACCOMMODATION

SPECIFICATION FOR MINIMUM REQUIREMENTS AND FINISHES TO WHICH THE BUILDING MUST COMPLY

1. GENERAL:

- (a) This specification forms part of the written offer of the bidder and must be initialled and submitted with all other documents.
- (b) Any requirements laid down in this specification shall be considered as supplementary to those set out in the written offer of the bidder and on the drawings. The fact that the Department checked the documentation and its acceptance thereof does not exempt the bidder from his responsibilities with regard to the fulfilment of the requirements of this specification.

2. CONSTRUCTION AND APPEARANCE OF BUILDING:

The design, construction and appearance of the building, including the internal and external finishes shall be of a standard acceptable to the Department of Public Works. The building must comply with the National Building Regulations as proclaimed by the National Building Regulations and Building Standards Act 1977 (Act 103 of 1977) as well as the Occupational Health and Safety Act, 1993 (Act 85 of 1993), as amended. The building shall be fully accessible to the disabled and the facilities must be provided as required by the Occupational Health and Safety Act, 1993 (Act 85 of 1993). A certificate to this effect must be submitted.

3. SECURITY:

The following security measures shall be complied with:

- (a) All entrances to the building, which shall be limited to the minimum, must afford entry through one or more access control points.
- (b) External walls of all floors, up to at least 1 metre above floor level, shall be of a heavyweight structure such as 220mm thick brick or 190mm thick concrete.

4. RECORD ROOMS:

- (a) Record rooms shall be rooms with category 1 record room doors which can be opened from both sides and which comply with SABS Specification 949. Record room walls shall be of masonry of not less than 220mm thick or of concrete of not less than 150mm thick or of such structure approved by the Department of Public Works.
- (b) Record rooms may have no external windows and all ventilation openings in the walls shall be fitted with fire dampers approved by the Fire Prevention Officer of the Department of Public Works.
- (c) All keys shall be handed over to the Department of Public Works.

5. ROOM AREAS AND PARTITIONS:

Partition walls shall be used to divide the total floor area of the building into office and other areas required. The walls shall have a noise reduction factor of not less than 45 dB within a range of 100 to 1000 hertz. The factor has a bearing on complete wall sections including glass and doors if any.

6. PASSAGE WIDTH:

As a general standard an average passage width with a minimum of 1.5m over short distances shall be provided. Where certain functions within the building necessitate wider passages those specific areas will be identified and the passage width specified as part of the accommodation particulars.

7. FLOOR TO CEILING HEIGHTS:

A clear floor to ceiling height of as close as possible to 2.7m throughout shall be maintained in all general areas of the building. Where a certain function inside a building necessitates a higher floor to ceiling height, the specific areas will be identified and the height specified as part of the accommodation particulars. Conduits, water pipes, air ducts and other services shall not be visible underneath the ceiling in offices and public areas.

8. DOORS, LOCKS AND KEYS:

All offices shall be provided with a door of at least 900mm and each fitted with a good quality five pin cylinder lock with two keys fitting one lock only and which shall be handed over to the Departmental Representative upon occupation of the building. Two master keys, which can unlock the locks of all offices, shall also be provided.

9. FLOOR COVERING:

Floor covering must be of an acceptable standard and quality to last for at least 10 years.

10. POWER POINTS:

(a) Offices and other rooms where electrical appliances can be used shall be provided with 15 A socket outlets. In offices two socket outlets shall be provided for every 12m² or part thereof. The Department of Public Works shall indicate any additional socket outlets, which are required, in the accommodation particulars for individual services. The wiring and securing of electrical circuits shall be such that an electrical heater as well as computer equipment can be run from the socket outlets in each office.

(b) Electrical circuits for socket outlets shall be secured by means of single phase earth leakage relays having a sensitivity of 25 mA.

11. LIGHTING:

(a) Each office shall be provided with its own light switch in a suitable position near the door. Lighting conforming to the following standard must be provided:

• Reception areas	100 lux
• General offices	300 lux
• Drawing office	500 lux
• Passages	50 lux
• Auditoriums	100 lux
• Conference rooms	100 lux
• Classrooms	200 lux
• Libraries	300 – 400 lux
• Store rooms	200 lux
• Parking	50 lux

(b) The lighting levels all measured at working plane.

12. TELEPHONES:

(a) Each office, conference room and security control area shall be fitted with a telephone jack in accordance with the requirements of Telkom.

(b) The user department itself will negotiate with Telkom as to the number of telephone lines that are to serve the building, but the owner of the building shall make provision for conduits, draw wires and telephone jacks.

13. TRUNKING:

The trunking servicing the building must conform to latest technological standards.

14. FACILITIES FOR CLEANERS

On every floor of a multi-storey building or for every 1 350m² gross floor area a cleaner's room of not less than 6m² shall be provided as a storeroom for cleaning equipment and material. It shall be provided with a drip sink, 4m long shelves and sufficient cross ventilation, preferably by means of an outside window and shall comply with the requirements of the Hazardous Chemicals Act regarding storage of chemicals.

15. TOILET FACILITIES:

The following norms shall be applied:

15.1. Males – staff and public

One WC for every 15 persons to a total of 60 and thereafter one for every 20 additional persons or part thereof. One urinal for every 15 persons to a total of 30 and thereafter 1 for every 30 additional persons or part thereof. One wash hand basin for every two WC's.

15.2. Females – staff and public

One WC (Water Closet) for every 10 persons to a total of 60 and thereafter one for every 20 additional persons or part thereof. One wash hand basin for every two WC's.

15.3. Physically challenged persons

Toilet facilities for physically challenged persons have to be provided according to norms and standards.

16. MATERIAL AND FINISHES:

- (a) All walls and ceilings, whether painted or finished otherwise, shall be of a neutral colour.
- (b) Walls of tea kitchens, stairs, entrance halls and toilets shall be washable and hardwearing and acceptable to the Department of Public Works.

17. INSPECTION:

The Department of Public Works considers it a condition of contract that in consultation with the lessor and with reasonable frequency during the process of refurbishment its inspector shall be given access to the building that he wishes to see. The inspector's approval of any part of the building does not exempt the owner from complying with any of these minimum standard requirements. A deviation from the minimum requirements may only be allowed with written permission from the Department of Public Works.



TERMS OF REFERENCE/ SPECIFICATIONS

PROJECT DESCRIPTION: LEASING OF OFFICE ACCOMMODATION

1. INTRODUCTION

- 1.1 The Department is responsible for procuring all leased office accommodation on behalf of National Department/s. In securing leased office accommodation, the primary objective of the Department, inter-alia, is to provide functional and best fit for use, type and location of office accommodation at optimal value to the Government.
- 1.2 Departments) that will conduct administrative business operations within the building. The Department intends accommodating user clients (other National
- 1.3 All bidders **MUST** respond to and comply with the following technical specifications and requirements that will be utilised by the Department to evaluate whether or not the building being offered by the bidder meets the minimum technical requirements of the Department.
- 1.4 It is required that the bidders **MUST** have a comment whether the building does meet the requirements on the table below. If it does not meet the requirements, the bidder **MUST** indicate how long it will take to meet the requirements in case of award. The period cannot be longer than the four months (04) allowed for tenant instalations.

2. MINIMUM TECHNICAL AND FUNCTIONAL REQUIREMENTS

2.1 General Accommodation

	REQUIRED	BIDDER'S COMMENTS
2.1	The accommodation must allow for the corporate image of the user Department to be enhanced and clearly visible from the street front.	
2.2	The electrical supply to the office accommodation must cater for both normal and clean (dedicated) power. Provision must be made for one (1) normal and one (1) clean plug point for every 6 m ² of useable office accommodation, an additional two (2) plug points per 150 m ² of Useable office accommodation to be allowed for to cater for fax, copiers etc. In addition, normal plugs to be provided in passages in order	

Annexure "B"

	REQUIRED	BIDDER'S COMMENTS
	<p>to accommodate cleaning machinery. (provision of interconnection power extension boxes with leads see "ANNEXURE C"</p> <p>In the kitchenette sufficient provision for plug points to be made for all electrical equipment. (minimum of 4 plugs and in the case of a kitchenette on each floor the same will be applicable). The kitchen must have hot and cold water.</p>	
2.3	<p>The accommodation must provide for adequate access for persons with physical disabilities etc. including toilet facilities both for the office environment as well as public interface area. Public toilets will remain part of useable area.</p> <p>Provision of a safe and secure wheelchair ramp and railings.</p> <p>Assisted ablution facility/facilities and with the requisite door handles (bar). Safe and secure handrails inside to be aligned to SAN 10 400.</p>	
2.4	<p>The office accommodation must cater for a combination of general open plan environment (for staff workstations, filing cabinets and a number of high-density filing cabinets) and enclosed offices for identified persons.</p> <p>Detailed information in terms of space norms and standards will be provided once tender is awarded.</p>	
2.5	<p>The landlord will be required to provide 50mm "plaswood" blinds and frosted vinyl (minimum, to door height.) on internal glass panels. See note 3 below for examples.</p> <p>An existing structure having ceiling board partitioning will be considered however should the offered building need to be constructed or additions made to an existing structure aluminium partitioning will be required in the corridors</p>	
2.6	<p>Fire protection equipment to be installed to comply with SANS 10400-T.</p> <p>Full Fire maintenance plan to be provided.</p>	
2.7	<p>All offices shall be provided with a semi solid hollow core door of at least</p>	

Annexure "B"

	REQUIRED	BIDDER'S COMMENTS
	813mmx2032 and each fitted with a good quality three pin cylinder lock with three keys fitting one lock only and which shall be handed over to the Departmental Representative at time of handing over of the building. The handles to be secured by means of male and female screws to ensure that the handles remain secured on the door leaf.	
2.8	Provision is to be made for at least (1) small kitchenette per 30 staff members, in which a sink as well as "hot and cold" water is available. Sink to be housed in an appropriate floor mounted cabinet complete with matching wall mounted cabinet's above. Cabinet – tops to be fitted with no less than a granite post formed top. Provision is to be made to house a microwave, floor standing fridge and a kettle.	
2.9	Floor covering must be of an acceptable standard and quality to last for at least ten years. Foyers, passages, kitchens bathrooms to be tiled either in a ceramic or porcelain tiles. Office to be carpeted with carpet tiles. No unfinished cement screed shall be permitted.	
2.10	The Department prefers a single tenant occupancy scenario and sharing the building with other tenants is not permitted unless there is a separate secure entrance.	

Note 1:

- a) The Department will pay only for a maximum usable space.
- b) In order to simplify the calculation of spatial requirements the "Useable Area" of the Building is to be used (as calculated by using the SAPOA method of measuring). This has no influence on the income generating value of the rentable space. The value of the common area is to be **added** to the rate per m² of the useable area.
- c) The reasoning is that all buildings have different R/U Ratio (Rentable area divided by Useable area) due to design criteria which could differ by up to 30%.
- d) For the purpose of ensuring that the actual **USEABLE** area is provided, it is essential that when calculating the **COMMON** area, both **Primary and Secondary Common** areas are to be factored in. Therefore, the Secondary common area shall remain part of the Common

Annexure "B"

area and **NOT** be included in the USEABLE area as is defined in clause 1.2.4 of the SAPOA method of measuring.

Note 2:

Examples of Frosted Vinyl

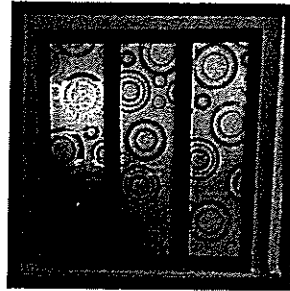
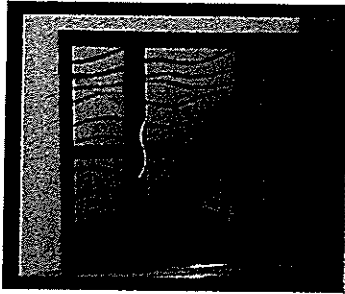

2.2 Lifts

	REQUIRED	BIDDER'S COMMENTS
1.	Adequate lifts must be available for staff to access the office work area from the ground floor of any building that has more than one (1) floor. (Lifts must be disabled friendly.)	
2.	Proof of a lift maintenance contract must be provided at site hand over. The maintenance contract must be in place for the duration of the contract.	

2.3 Air-conditioning

	REQUIRED	BIDDER'S COMMENTS
1.	The building must be fitted with a suitable and effective air-conditioning system, catering for the respective work areas (floors) as zones which operate independently. Fresh air to be supplied in office areas that have no direct access to opening windows	
2.	The bidder must indicate the type of air-conditioning system to be fitted/ fitted in the building. DPW will approve the type of air-conditioning that complies <i>Air-conditioning</i> type	

Annexure "B"

3.	The landlord shall be responsible for the maintenance and repairs in respect of the air-conditioning system during the period of lease.	
4.	The landlord will conclude a contract with an independent air-conditioning contractor in terms of which: <ul style="list-style-type: none"> • Complaints in respect of the reported air-conditioning problems need to be logged and responded to within a period of (2-4) hours of being reported. • Complaints reported in respect of air-conditioning problems need to be resolved with (24) hours after the initial report. 	
5.	An air-conditioning maintenance contract must be provided at the time of site handover. The maintenance contract must be in place for the duration of the contract.	

2.4 Emergency Power Supply

	REQUIRED	BIDDER'S COMMENTS
1.	The building must have an emergency power supply unit subject to the size of the building to ensure essential areas, emergency lifts, emergency lighting, computer server room, computer workstations etc., are functioning in the event of a power failure, load shedding, at occupation.	
2.	Bidders must indicate the make and electrical capacity of the emergency power supply unit installed in the building and also provide a list of the standard equipment that it is currently connected to. Make..... Capacity.....	
3.	An indication of how long (duration) the emergency power supply unit can provide emergency power to the standard equipment currently connected. Duration	

2.5 Emergency Water Supply

	REQUIRED	BIDDER'S COMMENTS
1.	The landlord must provide at least a minimum of two (2) water tank (2*5000 litres Jojo tank with a pressure pump) as a water backup supply during office hours. In case of a double storey building, the tank must be elevated to assist the pressure of water supply to all floors.	

Annexure "B"

2.	Should water shading be implemented by local authorities, the water supply mentioned above should be sufficient to cover a period of two days and more. A regular maintenance of all water related equipment is compulsory.	

2.6 IT Server Room

	REQUIRED	BIDDER'S COMMENTS
1.	The landlord will be required to provide a 12m ² server room to be constructed out of brick and mortar (230mm thick). The sever room is to be fitted with two compartment (UPVC) power skirting and CAT6 data cabling in terms of the SITA minimum requirements for server rooms for Government/ Parastatal institutions. The server room is to be secured by means of a biometric/ keypad access control system. Fire Supression systems panel alerting system with a 3 year maintenance plan performed half yearly .Raised flooring to prevent damage to equipment in the event of flooding. 1.2m wide Fireproof door with a one and half hour fire rating..	
2.	The server room must be equipped with 2 by 9000 BTU independent air-conditioning unit to cater for the computer equipment. The sever room be equipped with an earth bar in accordance with Telkom Standards. (One unit to serve as a backup unit)	
3.	The landlord will be required to provide power skirting and ICT (CAT6) cabling in accordance to the latest technical specifications (KRONE Standards) to all workstations, pause rooms – two (2) data points each, Boardrooms-ten (10) data points in each, and five (5) for open plan printing stations, Fly leads to be provided as per approved layouts, 8x Aruba 515 AIP access points with relevant licenses (Aruba airwave) configured and linked to existing Airwave server to be provided to ensure coverage for the entire premises. The Landlord will be required to connect and patch cables, including fibre connectivity, into the cabinets (supplied and installed by the Landlord with 32 AMP connectors feeding to the UPS). UPS to be resistant to surges during load shedding.	

2.7 Security Requirements

	REQUIRED	BIDDER'S COMMENTS
1.	The landlord will be required to provide full height turnstiles to be installed complete with a biometric and card reader system (hardware and software to be included), CCTV cameras to be installed at all entrances and linked to the system.	

Annexure "B"

	REQUIRED	BIDDER'S COMMENTS
2.	The landlord will be required to provide a boom gate and guardroom in the parking area.	
3.	The landlord will be required to provide burglar bars for all windows at least at ground floor level.	

Acknowledgement of Departmental Specification

Signed _____ Date _____

Name _____ Position _____

POWER EXTENSION BOXES

- Item 01: Alpha horizontal power dock unit**
- 2 x End caps
 - 1 x On Off Switch
 - 1 x SA Standard 3 pin socket
 - 1 x SA dedicated 3 pin socket
 - 1 x 2 Pin German socket
 - 2 x Voice & data – bezels only
 - **Operating voltage:** 110V to 250 VAC @ 50/60Hz
 - **Input cable type:** 16A or 20A
 - (Bezel connections to be installed by others)
- Item 02: Input power cables**
- 3m / 5m
 - 1 x Clean & 1 x Dedicated
- Item 03: Interconnecting power cables**
- 2m
 - 1 x Clean & 1 x Dedicated

Note: All workstations to receive a power dock unit. (Supply and Install)

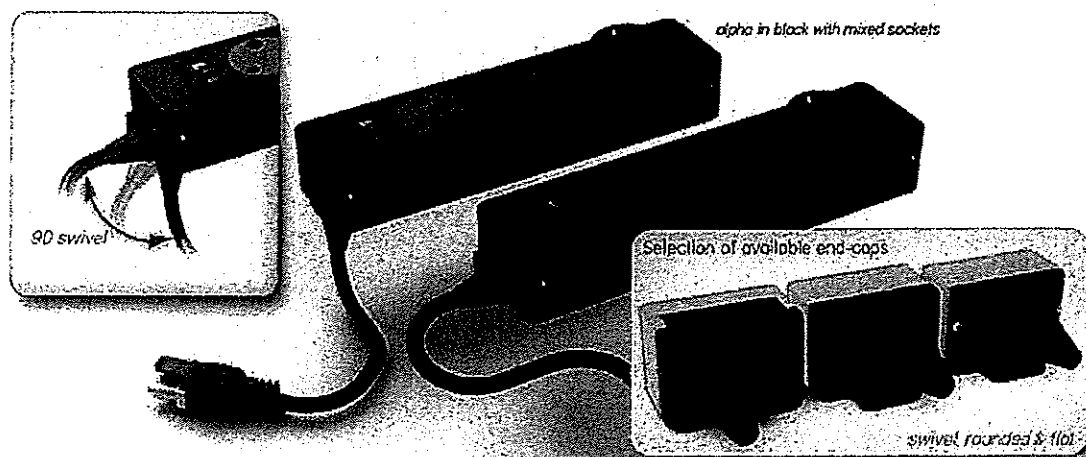

DPW – 08.1 (LS): BID OFFER – OFFICE ACCOMMODATION

Bid no:	CPTL36/21	Closing date:	18 March 2022
Advertising date:	25 February 2022	Validity period:	60 days

1. ACCOMMODATION PARTICULARS

Name of building	
Address of building	
Market Value of building	
Municipal valuation of building	
Gross floor area of accommodation	m ²
Date accommodation may be occupied	
Commencement date of lease	
Lease period	
Option period	
Value Added Tax Number	

2. RENTALS (OFFICES, STORES AND PARKING)

	Offices	Stores	Parking
Lettable Area	m ²	m ²	
Parking bays			
Rental per month	R		R
VAT per month	R		R
Total per month	R		R
Tariffs	R /m ²	R /m ²	R each
VAT	R /m ²	R /m ²	R each
Total (1)	R /m ²	R /m ²	R each
Escalation Rate	%	%	%
Operating Costs (Provide details on what costs entail)	R /m ²	R /m ²	
VAT	R /m ²	R /m ²	
Total (2)	R /m ²	R /m ²	
Escalation Rate	%		
Total (1 + 2)	R /m ²	R /m ²	R each
Alteration Cost for Lessor:	R	R	

3. RESPONSIBILITIES

Note: The state is not prepared to accept responsibility for services or costs involved as per grey areas.
 (Indicate where applicable)

3.1. Services	State	Lessor	Estimated cost per month
3.1.1. Water consumption			
3.1.2. Electricity consumption			
3.1.3. Sanitary services			
3.1.4. Refuse removal			
3.1.5. Domestic cleaning service			
3.1.6. Consumable Supplies			

3.2. Maintenance	State	Lessor	Estimated cost per month
3.2.1. Internal maintenance			
3.2.2. External			
3.2.3. Garden (If applicable)			
3.2.4. Air conditioning			
3.2.5. Lifts			
3.2.6. Floor covering: normal wear			

3.3. Rates and Insurance	State	Lessor	Estimated cost per month
3.3.1. Municipal rates & Increases			
3.3.2. Insurance & Increases			
3.3.3. SASRIA insurance + Increase			

3.4. Other Responsibilities	State	Lessor	Estimated cost per month
3.4.1. Contract costs			
3.4.2. Stamp duty			
3.4.3. Fire fighting equipment			
3.4.4. Cost of alterations			

Note: State is not prepared to accept responsibility for costs involved within grey coloured columns

Does the building comply with the National Building Regulations?	<input type="checkbox"/> Yes	<input type="checkbox"/> No
--	------------------------------	-----------------------------

4. NATIONAL BUILDING REGULATIONS:

Electricity Compliance Certificate	<input type="checkbox"/> Yes <input type="checkbox"/> No
Fire Regulation	<input type="checkbox"/> Yes <input type="checkbox"/> No
Accessibility Regulation	<input type="checkbox"/> Yes <input type="checkbox"/> No
Health and Safety Regulation	<input type="checkbox"/> Yes <input type="checkbox"/> No

5. PARTICULARS FOR PAYMENT OF RENTAL:

Person/Organisation to whom cheque must be issued	
Postal address	
Telephone no.	
Cell. No.	
e-mail address	

6. INCOME TAX REFERENCE NUMBER:

INCOME TAX REFERENCE NUMBER (in terms of Section 69 of the Income Tax Act, 1962 (Act 58 of 1962) as amended)	
--	--

Name of owner / Duly authorised representative	Signature	Date

PA-11: DECLARATION OF INTEREST AND BIDDER'S PAST SUPPLY CHAIN MANAGEMENT PRACTICES

Failure to complete this form in **full** and signed by the duly authorized person, as indicated on PA-15.1 or PA-15.3, shall render the tender non-responsive and will be removed from any and all further contention.

Project title:	OPEN TENDER PROCEDURE TO PROCURE NEW OFFICE ACCOMMODATION FOR SASSA: KHAYELITSHA OFFICE 2: FOR A PERIOD OF FIVE (5) YEARS: LETTABLE GUIDELINE: 964.45 m², 2 LOCK UP GARAGES, 9 UNDER COVER AND SECURED PARKING BAYS		
Bid no:	CPTL36/21	Reference no:	

The following particulars must be furnished. In the case of a joint venture, separate declarations in respect of each partner must be completed and submitted.

1. CIDB REGISTRATION NUMBER (if applicable)

2. Any legal person, including persons employed by the State¹; or persons having a kinship with persons employed by the state, including a blood relationship, may make an offer or offers in terms of this invitation to bid (includes a price quotation, advertised competitive bid, limited bid or proposal). In view of possible allegations of favouritism, should the resulting bid, or part thereof, be awarded to persons employed by the state, or to persons connected with or related to them, it is required that the bidder or his/her authorised representative declare his/her position in relation to the evaluating/adjudicating authority and/or take an oath declaring his/her interest, where:

- The bidder is employed by the state; and/or
- The legal person on whose behalf the bidding document is signed, has a relationship with persons/a person who are/is involved in the evaluation and or adjudication of the bid(s), or where it is known that such a relationship exists between the person or persons for or on whose behalf the declarant acts and persons who are involved with the evaluation and or adjudication of the bid.

3. In order to give effect to the above, the following questionnaire must be completed and submitted with the bid.

- 3.1 Full Name of bidder or his or her representative:
- 3.2 Identity number:.....
- 3.3 Position occupied in the Company (director, trustees, shareholder² ect
- 3.4 Company Registration Number:
- 3.5 Tax Reference umber:.....
- 3.6 VAT Registration Number:

3.6.1 The names of all directors / trustees / shareholders / members, their individual identity numbers, tax reference numbers and, if applicable, employee / persal numbers must be indicated in paragraph 3 below.

¹ "State" means –

- (a) any national or provincial department, national or provincial public entity or constitutional institution within the meaning of the Public Finance Management Act, 1999 (Act No. 1 of 1999);
- (b) any municipality or municipal entity;
- (c) provincial legislature;
- (d) national Assembly or the national Council of provinces; or
- (e) Parliament.

² "Shareholder" means –

- (a) a person who owns shares in the company and is actively involved in the management of the enterprise or business and exercise control over the enterprise

3.7 Are you or any person connected with the bidder presently employed by the state? YES NO

3.7.1 If so, furnish the following particulars:

Name of person / director /trustees/shareholder/ member:.....

Name of state institution at which you or the person is connected to the bidder is employed

Position occupied in the state institution:.....

Any other particulars:

.....
.....

3.8 Did you or your spouse, or any of the company's directors / trustees/shareholders / members or their spouses conduct business with the state in the previous twelve months? YES NO

3.8.1 If so, furnish particulars:.....
.....

3.9 Do you, or any person connected with the bidder, have any relationship (family, friend, other) with a person employed by the state and who may be involved with the evaluation and or adjudication of this bid? YES NO

3.9.1 If so, furnish particulars.
.....
.....

3.10 Are you, or any person connected with the bidder, aware of any relationship (family, friend, other between the bidder and any person employed by the state who may be involved with the evaluation and or adjudication of this bid? YES NO

3.10.1 If so, furnish particulars.

.....
.....

3.11 Do you or any of the directors /trustees/shareholders/ members of the company have any interest in any other related companies whether or not they are bidding for this contract? YES NO

3.11.1 If so, furnish particulars:

.....
.....

4. Full details of directors / trustees / members / shareholders.

Full Name	Identity Number	Personal Tax Reference Number	State Employee Number / Persal Number

5. DECLARATION OF TENDERER / BIDDER'S PAST SUPPLY CHAIN MANAGEMENT PRACTICES

5.1	<i>Is the tenderer / bidder or any of its directors listed on the National Treasury's database as companies or persons prohibited from doing business with the public sector?</i> (Companies or persons who are listed on this database were	<input type="checkbox"/> Yes	<input type="checkbox"/> No
-----	--	--	------------------------------------

	informed in writing of this restriction by the National Treasury after the audi alteram partem rule was applied).		
5.2	<i>If so, furnish particulars:</i>		
5.3	<p><i>Is the tenderer / bidder or any of its directors listed on the Register for Tender Defaulters in terms of section 29 of the Prevention and Combating of Corrupt Activities Act (No 12 of 2004)?</i></p> <p>To access this Register enter the National Treasury's website, www.treasury.gov.za, click on the icon "Register for Tender Defaulters" or submit your written request for a hard copy of the Register to facsimile number (012) 3265445.</p>	<input type="checkbox"/> Yes	<input type="checkbox"/> No
5.4	<i>If so, furnish particulars:</i>		
5.5	<i>Was the tenderer / bidder or any of its directors convicted by a court of law (including a court outside of the Republic of South Africa) for fraud or corruption during the past five years?</i>	<input type="checkbox"/> Yes	<input type="checkbox"/> No
5.6	<i>If so, furnish particulars:</i>		
5.7	<i>Was any contract between the tenderer / bidder and any organ of state terminated during the past five years on account of failure to perform on or comply with the contract?</i>	<input type="checkbox"/> Yes	<input type="checkbox"/> No
5.8	<i>If so, furnish particulars:</i>		

6. CERTIFICATION

I the undersigned (full name) _____ certify that the information furnished on this declaration form is true and correct.

I accept that, in addition to cancellation of a contract, action may be taken against me should this declaration prove to be false.

Name of Tenderer / bidder	Signature	Date	Position

This form has been aligned with SBD4 and SBD 8



PA-15.1: RESOLUTION OF BOARD OF DIRECTORS

RESOLUTION of a meeting of the Board of *Directors / Members / Partners of:

(legally correct full name and registration number, if applicable, of the Enterprise)

Held at _____ (place)

on _____ (date)

RESOLVED that:

- 1. The Enterprise submits a Bid / Tender to the Department of Public Works in respect of the following project:

(project description as per Bid / Tender Document)

Bid / Tender Number: _____ (Bid / Tender Number as per Bid / Tender Document)

- 2. *Mr/Mrs/Ms: _____

in *his/her Capacity as: _____ (Position in the Enterprise)

and who will sign as follows: _____

be, and is hereby, authorised to sign the Bid / Tender, and any and all other documents and/or correspondence in connection with and relating to the Bid / Tender, as well as to sign any Contract, and any and all documentation, resulting from the award of the Bid / Tender to the Enterprise mentioned above.

Table with 4 columns: Name, Capacity, Signature and a numbered row (1-14).



15			
16			
17			
18			
19			
20			

The bidding enterprise hereby absolves the Department of Public Works from any liability whatsoever that may arise as a result of this document being signed.

Note:

1. * Delete which is not applicable.
2. **NB:** This resolution must, where possible, be signed by all the Directors / Members / Partners of the Bidding Enterprise.
3. In the event that paragraph 2 cannot be complied with, the resolution must be signed by Directors / Members / Partners holding a majority of the shares / ownership of the Bidding Enterprise (attach proof of shareholding / ownership hereto).
4. Directors / Members / Partners of the Bidding Enterprise may alternatively appoint a person to sign this document on behalf of the Bidding Enterprise, which person must be so authorized by way of a duly completed power of attorney, signed by the Directors / Members / Partners holding a majority of the shares / ownership of the Bidding Enterprise (proof of shareholding / ownership and power of attorney are to be attached hereto).
5. Should the number of Directors / Members / Partners exceed the space available above, additional names and signatures must be supplied on a separate page.

ENTERPRISE STAMP



Resolution of Board of Directors to enter into Consortia or Joint Ventures: PA-15.2

PA-15.2: RESOLUTION OF BOARD OF DIRECTORS TO ENTER INTO CONSORTIA OR JOINT VENTURES

RESOLUTION of a meeting of the Board of *Directors / Members / Partners of:

(Legally correct full name and registration number, if applicable, of the Enterprise)

Held at _____ *(place)*

on _____ *(date)*

RESOLVED that:

1. The Enterprise submits a Bid /Tender, in consortium/Joint Venture with the following Enterprises:

(List all the legally correct full names and registration numbers, if applicable, of the Enterprises forming the Consortium/Joint Venture)

to the Department of Public Works in respect of the following project:

(Project description as per Bid /Tender Document)

Bid / Tender Number: _____ *(Bid / Tender Number as per Bid / Tender Document)*

2. *Mr/Mrs/Ms: _____

in *his/her Capacity as: _____ *(Position in the Enterprise)*

and who will sign as follows: _____

be, and is hereby, authorised to sign a consortium/joint venture agreement with the parties listed under item 1 above, and any and all other documents and/or correspondence in connection with and relating to the consortium/joint venture, in respect of the project described under item 1 above.

3. The Enterprise accepts joint and several liability with the parties listed under item 1 above for the due fulfilment of the obligations of the joint venture deriving from, and in any way connected with, the Contract to be entered into with the Department in respect of the project described under item 1 above.
4. The Enterprise chooses as its *domicilium citandi et executandi* for all purposes arising from this joint venture agreement and the Contract with the Department in respect of the project under item 1 above:

Physical address: _____



public works
& infrastructure

Department:
Public Works and Infrastructure
REPUBLIC OF SOUTH AFRICA

Resolution of Board of Directors to enter into Consortia or Joint Ventures: PA-15.2

_____ (code)



**public works
& infrastructure**

Department:
Public Works and Infrastructure
REPUBLIC OF SOUTH AFRICA

Resolution of Board of Directors to enter into Consortia or Joint Ventures: PA-15.2

Postal Address: _____

 _____ (code)

Telephone number: _____

Fax number: _____

	Name	Capacity	Signature
1			
2			
3			
4			
5			
6			
7			
8			
9			
10			
11			
12			
13			
14			
15			

The bidding enterprise hereby absolves the Department of Public Works from any liability whatsoever that may arise as a result of this document being signed

Note:

- * Delete which is not applicable.*
- NB:** This resolution must, where possible, be signed by all the Directors / Members / Partners of the Bidding Enterprise.*
- In the event that paragraph 2 cannot be complied with, the resolution must be signed by Directors / Members / Partners holding a majority of the shares / ownership of the Bidding Enterprise (attach proof of shareholding / ownership hereto).*
- Directors / Members / Partners of the Bidding Enterprise may alternatively appoint a person to sign this document*

ENTERPRISE STAMP



public works
& infrastructure

Department:
Public Works and Infrastructure
REPUBLIC OF SOUTH AFRICA

Resolution of Board of Directors to enter into Consortia or Joint Ventures: PA-15.2

on behalf of the Bidding Enterprise, which person must be so authorized by way of a duly completed power of attorney, signed by the Directors / Members / Partners holding a majority of the shares / ownership of the Bidding Enterprise (proof of shareholding / ownership and power of attorney are to be attached hereto).

5. *Should the number of Directors / Members / Partners exceed the space available above, additional names and signatures must be supplied on a separate page.*

--

PA-15.3: SPECIAL RESOLUTION OF CONSORTIA OR JOINT VENTURES

RESOLUTION of a meeting of the duly authorised representatives of the following legal entities who have entered into a consortium/joint venture to jointly bid for the project mentioned below: *(legally correct full names and registration numbers, if applicable, of the Enterprises forming a Consortium/Joint Venture)*

1. _____

2. _____

3. _____

4. _____

5. _____

6. _____

7. _____

8. _____

Held at _____ *(place)*

on _____ *(date)*

RESOLVED that:

RESOLVED that:

- A. The above-mentioned Enterprises submit a Bid in Consortium/Joint Venture to the Department of Public Works in respect of the following project:

(Project description as per Bid /Tender Document)

Bid / Tender Number: _____ *(Bid / Tender Number as per Bid /Tender Document)*



B. *Mr/Mrs/Ms: _____
in *his/her Capacity as: _____ (Position in the Enterprise)
and who will sign as follows: _____

be, and is hereby, authorised to sign the Bid, and any and all other documents and/or correspondence in connection with and relating to the Bid, as well as to sign any Contract, and any and all documentation, resulting from the award of the Bid to the Enterprises in Consortium/Joint Venture mentioned above.

C. The Enterprises constituting the Consortium/Joint Venture, notwithstanding its composition, shall conduct all business under the name and style of:

D. The Enterprises to the Consortium/Joint Venture accept joint and several liability for the due fulfilment of the obligations of the Consortium/Joint Venture deriving from, and in any way connected with, the Contract entered into with the Department in respect of the project described under item A above.

E. Any of the Enterprises to the Consortium/Joint Venture intending to terminate the consortium/joint venture agreement, for whatever reason, shall give the Department 30 days written notice of such intention. Notwithstanding such decision to terminate, the Enterprises shall remain jointly and severally liable to the Department for the due fulfilment of the obligations of the Consortium/Joint Venture as mentioned under item D above.

F. No Enterprise to the Consortium/Joint Venture shall, without the prior written consent of the other Enterprises to the Consortium/Joint Venture and of the Department, cede any of its rights or assign any of its obligations under the consortium/joint venture agreement in relation to the Contract with the Department referred to herein.

G. The Enterprises choose as the *domicilium citandi et executandi* of the Consortium/Joint Venture for all purposes arising from the consortium/joint venture agreement and the Contract with the Department in respect of the project under item A above:

Physical address: _____

_____ (code)

Postal Address: _____

_____ (code)

Telephone number: _____

Fax number: _____



	Name	Capacity	Signature
1			
2			
3			
4			
5			
6			
7			
8			
9			
10			
11			
12			
13			
14			
15			

The bidding enterprise hereby absolves the Department of Public Works from any liability whatsoever that may arise as a result of this document being signed.

Note:

1. * Delete which is not applicable.
2. **NB:** This resolution must be signed by all the Duly Authorised Representatives of the Legal Entities to the consortium/joint venture submitting this tender, as named in item 2 of Resolution PA-15.2.
3. Should the number of the Duly Authorised Representatives of the Legal Entities joining forces in this tender exceed the space available above, additional names, capacity and signatures must be supplied on a separate page.
4. Resolution PA-15.2, duly completed and signed, from the separate Enterprises who participate in this consortium/joint venture, must be attached to this Special Resolution (PA-15.3).

DPW-12 (LS): COMPLIANCE WITH ALL THE ACTS, REGULATIONS AND BY- LAWS GOVERNING THE BUILT ENVIRONMENT CERTIFICATE

Bid no:	CPTL36/21	Closing date:	18 March 2022
Advertising date:	25 February 2022	Validity period:	60 Days

COMPLIANCE WITH ALL THE ACTS, REGULATIONS AND BY- LAWS GOVERNING THE BUILT ENVIRONMENT

I, _____ duly authorised to represent _____ (the bidders name) acknowledge that I as _____ shall ensure that _____ (description of the property in question) complies in every respect with the requirements of the following Acts, Regulations and By - Laws:

- (i) Occupational Health and Safety Act, 1993. (Act 85 of 1993)
- (ii) The National Building Regulations and Building Standards Act, 1977 (Act 103 of 1977)
- (iii) The Municipal by-laws and any special requirements of the local supply authority.
- (iv) The local fire regulations, to guarantee/ensure the health and safety of all State employees occupying this/these premises and the public visiting the premises for business or other purposes.

I furthermore agree to advise the Department of Public Works immediately in writing of any reason I am unable to perform in terms of this agreement and to apply the necessary corrective measures.

Name owner / authorised representative	Signature	Date

1. WITNESS:

Name of witness	Signature	Date

2. WITNESS:

Name of witness	Signature	Date

**PREFERENCE POINTS CLAIM FORM IN TERMS OF THE PREFERENTIAL
 PROCUREMENT REGULATIONS 2017**

This preference form must form part of all bids invited. It contains general information and serves as a claim form for preference points for Broad-Based Black Economic Empowerment (B-BBEE) Status Level of Contribution

NB: BEFORE COMPLETING THIS FORM, BIDDERS MUST STUDY THE GENERAL CONDITIONS, DEFINITIONS AND DIRECTIVES APPLICABLE IN RESPECT OF B-BBEE, AS PRESCRIBED IN THE PREFERENTIAL-PROCUREMENT REGULATIONS, 2017.

1. GENERAL CONDITIONS

- 1.1. The following preference point systems are applicable to all bids:
- the 80/20 system for requirements with a Rand value of up to R50 000 000 (all applicable taxes included); and
 - the 90/10 system for requirements with a Rand value above R50 000 000 (all applicable taxes included).

- 1.2.
- a) The value of this bid is estimated to **not exceed** R50 000 000 (all applicable taxes included) and therefore the **80/20** preference point system shall be applicable; or
 - b) Either the 80/20 or 90/10 preference point system will be applicable to this tender (*delete whichever is not applicable for this tender*).

- 1.3. Points for this bid shall be awarded for:
- (a) Price; and
 - (b) B-BBEE Status Level of Contributor.

- 1.4. The maximum points for this bid are allocated as follows:

	POINTS
PRICE	80
B-BBEE STATUS LEVEL OF CONTRIBUTOR	20
Total points for Price and B-BBEE must not exceed	100

- 1.5. Failure on the part of a bidder to submit proof of B-BBEE Status level of contributor together with the bid, will be interpreted to mean that preference points for B-BBEE status level of contribution are not claimed.
- 1.6. The purchaser reserves the right to require of a bidder, either before a bid is adjudicated or at any time subsequently, to substantiate any claim in regard to preferences, in any manner required by the purchaser.

2. DEFINITIONS

- (a) **“B-BBEE”** means broad-based black economic empowerment as defined in section 1 of the Broad-Based Black Economic Empowerment Act;
- (b) **“B-BBEE status level of contributor”** means the B-BBEE status of an entity in terms of a code of good practice on black economic empowerment, issued in terms of section 9(1) of the Broad-Based Black Economic Empowerment Act;
- (c) **“bid”** means a written offer in a prescribed or stipulated form in response to an invitation by an organ of state for the provision of goods or services, through price quotations, advertised competitive bidding processes or proposals;
- (d) **“Broad-Based Black Economic Empowerment Act”** means the Broad-Based Black Economic Empowerment Act, 2003 (Act No. 53 of 2003);
- (e) **“EME”** means an Exempted Micro Enterprise in terms of a code of good practice on black economic empowerment issued in terms of section 9 (1) of the Broad-Based Black Economic Empowerment Act;
- (f) **“functionality”** means the ability of a tenderer to provide goods or services in accordance with specifications as set out in the tender documents.
- (g) **“prices”** includes all applicable taxes less all unconditional discounts;
- (h) **“proof of B-BBEE status level of contributor”** means:
 - 1) certificate issued by an authorized body or person; B-BBEE Status level
 - 2) prescribed by the B-BBEE Codes of Good Practice; A sworn affidavit as
 - 3) requirement prescribed in terms of the B-BBEE Act; Any other
- (i) **“QSE”** means a qualifying small business enterprise in terms of a code of good practice on black economic empowerment issued in terms of section 9 (1) of the Broad-Based Black Economic Empowerment Act;
- (j) **“rand value”** means the total estimated value of a contract in Rand, calculated at the time of bid invitation, and includes all applicable taxes;

3. POINTS AWARDED FOR PRICE

1.1. THE 80/20 OR 90/10 PREFERENCE POINT SYSTEMS

A maximum of 80 or 90 points is allocated for price on the following basis:

80/20	or	90/10	
$P_s = 80 \left(1 - \frac{P_t - P_{min}}{P_{min}} \right)$	or	$P_s = 90 \left(1 - \frac{P_t - P_{min}}{P_{min}} \right)$	

Where

- P_s = Points scored for price of bid under consideration
- P_t = Price of bid under consideration
- P_{min} = Price of lowest acceptable bid

Any reference to words "Bid" or Bidder" herein and/or in any other documentation shall be construed to have the same meaning as the words "Tender" or "Tenderer".

4. POINTS AWARDED FOR B-BBEE STATUS LEVEL OF CONTRIBUTOR

1.1. In terms of Regulation 6 (2) and 7 (2) of the Preferential Procurement Regulations, preference points must be awarded to a bidder for attaining the B-BBEE status level of contribution in accordance with the table below:

B-BBEE Status Level of Contributor	Number of points (90/10 system)	Number of points (80/20 system)
1	10	20
2	9	18
3	6	14
4	5	12
5	4	8
6	3	6
7	2	4
8	1	2
Non-compliant contributor	0	0

5. BID DECLARATION

1.1. Bidders who claim points in respect of B-BBEE Status Level of Contribution must complete the following:

6. B-BBEE STATUS LEVEL OF CONTRIBUTOR CLAIMED IN TERMS OF PARAGRAPHS 1.4 AND 4.1

1.1. B-BBEE Status Level of Contributor: . =(maximum of 10 or 20 points)
 (Points claimed in respect of paragraph 7.1 must be in accordance with the table reflected in paragraph 4.1 and must be substantiated by relevant proof of B-BBEE status level of contributor.)

7. SUB-CONTRACTING

1.1. Will any portion of the contract be sub-contracted?

(Tick applicable box)

YES	<input type="checkbox"/>	NO	<input type="checkbox"/>
-----	--------------------------	----	--------------------------

7.1.1 If yes, indicate:

- i) What percentage of the contract will be subcontracted.....%
- ii) The name of the sub-contractor.....
- iii) The B-BBEE status level of the sub-contractor.....
- iv) Whether the sub-contractor is an EME or QSE

(Tick applicable box)

YES	<input type="checkbox"/>	NO	<input type="checkbox"/>
-----	--------------------------	----	--------------------------

v) Specify, by ticking the appropriate box, if subcontracting with an enterprise in terms of Preferential Procurement Regulations, 2017:

Designated Group: An EME or QSE which is at least 51% owned by:	EME	QSE
	√	√
Black people		
Black people who are youth		
Black people who are women		
Black people with disabilities		
Black people living in rural or underdeveloped areas or townships		
Cooperative owned by black people		
Black people who are military veterans		
OR		
Any EME		
Any QSE		

8. DECLARATION WITH REGARD TO COMPANY/FIRM

1.1. Name of company/firm:.....

1.2. VAT registration number:.....

1.3. Company registration number:.....

1.4. TYPE OF COMPANY/ FIRM

Partnership/Joint Venture / Consortium

One person business/sole propriety

Close corporation

Company

(Pty) Limited

[TICK APPLICABLE BOX]

1.5. DESCRIBE PRINCIPAL BUSINESS ACTIVITIES

.....

1.6. COMPANY CLASSIFICATION

Manufacturer

Supplier

Professional service provider

Other service providers, e.g. transporter, etc.

[TICK APPLICABLE BOX]

1.7. Total number of years the company/firm has been in business:.....

1.8. I/we, the undersigned, who is / are duly authorised to do so on behalf of the company/firm, certify that the points claimed, based on the B-BBE status level of contributor indicated in



paragraphs 1.4 and 6.1 of the foregoing certificate, qualifies the company/ firm for the preference(s) shown and I / we acknowledge that:

- i) The information furnished is true and correct;
- ii) The preference points claimed are in accordance with the General Conditions as indicated in paragraph 1 of this form;
- iii) In the event of a contract being awarded as a result of points claimed as shown in paragraphs 1.4 and 6.1, the contractor may be required to furnish documentary proof to the satisfaction of the purchaser that the claims are correct;
- iv) If the B-BBEE status level of contributor has been claimed or obtained on a fraudulent basis or any of the conditions of contract have not been fulfilled, the purchaser may, in addition to any other remedy it may have –
 - (a) disqualify the person from the bidding process;
 - (b) recover costs, losses or damages it has incurred or suffered as a result of that person's conduct;
 - (c) cancel the contract and claim any damages which it has suffered as a result of having to make less favourable arrangements due to such cancellation;
 - (d) recommend that the bidder or contractor, its shareholders and directors, or only the shareholders and directors who acted on a fraudulent basis, be restricted by the National Treasury from obtaining business from any organ of state for a period not exceeding 10 years, after the *audi alteram partem* (hear the other side) rule has been applied; and
 - (e) forward the matter for criminal prosecution.

WITNESSES

.....

PA- 29: CERTIFICATION OF INDEPENDENT BID DETERMINATION

Project title:	OPEN TENDER PROCEDURE TO PROCURE NEW OFFICE ACCOMMODATION FOR SASSA: KHAYELITSHA OFFICE 2: FOR A PERIOD OF FIVE (5) YEARS: LETTABLE GUIDELINE: 964.45 m ² , 2 LOCK UP GARAGES, 9 UNDER COVER AND SECURED PARKING BAYS		
Bid no:	CPTL36/21	Reference no:	

INTRODUCTION

1. This PA-29 [Certificate of Independent Bid Determination] must form part of all bids¹ invited.
2. Section 4 (1) (b) (iii) of the Competition Act No. 89 of 1998, as amended, prohibits an agreement between, or concerted practice by, firms, or a decision by an association of firms, if it is between parties in a horizontal relationship and if it involves collusive bidding (or bid rigging).² Collusive bidding is a *pe se* prohibition meaning that it cannot be justified under any grounds.
3. Treasury Regulation 16A9 prescribes that accounting officers and accounting authorities must take all reasonable steps to prevent abuse of the supply chain management system and authorizes accounting officers and accounting authorities to:
 - a. disregard the bid of any bidder if that bidder, or any of its directors have abused the institution's supply chain management system and or committed fraud or any other improper conduct in relation to such system.
 - b. cancel a contract awarded to a supplier of goods and services if the supplier committed any corrupt or fraudulent act during the bidding process or the execution of that contract.
4. This form (PA-29) serves as a certificate of declaration that would be used by institutions to ensure that, when bids are considered, reasonable steps are taken to prevent any form of bid-rigging.
5. In order to give effect to the above, the attached Certificate of Bid Determination (PA-29) must be completed and submitted with the bid:

¹ Includes price quotations, advertised competitive bids, limited bids and proposals.

² Bid rigging (or collusive bidding) occurs when businesses, that would otherwise be expected to compete, secretly conspire to raise prices or lower the quality of goods and / or services for purchasers who wish to acquire goods and / or services through a bidding process. Bid rigging is, therefore, an agreement between competitors not to compete.

CERTIFICATE OF INDEPENDENT BID DETERMINATION

I, the undersigned, in submitting the accompanying bid:

(Bid Number and Description)

in response to the invitation for the bid made by:

(Name of Institution)

do hereby make the following statements that I certify to be true and complete in every respect:

I certify, on behalf of: _____ that:

(Name of Bidder)

1. I have read and I understand the contents of this Certificate.
2. I understand that the accompanying bid will be disqualified if this Certificate is found not to be true and complete in every respect.
3. I am authorized by the bidder to sign this Certificate, and to submit the accompanying bid, on behalf of the bidder.
4. Each person whose signature appears on the accompanying bid has been authorized by the bidder to determine the terms of, and to sign the bid, on behalf of the bidder.
5. For the purposes of this Certificate and the accompanying bid, I understand that the word "competitor" shall include any individual or organization, other than the bidder, whether or not affiliated with the bidder, who:

- (a) has been requested to submit a bid in response to this bid invitation;
 - (b) could potentially submit a bid in response to this bid invitation, based on their qualifications, abilities or experience; and
 - (c) provides the same goods and services as the bidder and/or is in the same line of business as the bidder.
6. The bidder has arrived at the accompanying bid independently from, and without consultation, communication, agreement or arrangement with any competitor. However communication between partners in a joint venture or consortium³ will not be construed as collusive bidding.
7. In particular, without limiting the generality of paragraphs 6 above, there has been no consultation, communication, agreement or arrangement with any competitor regarding:
 - (a) prices;
 - (b) geographical area where product or service will be rendered (market allocation)
 - (c) methods, factors or formulas used to calculate prices;
 - (d) the intention or decision to submit or not to submit, a bid;
 - (e) the submission of a bid which does not meet the specifications and conditions of the bid; or
 - (f) bidding with the intention not to win the bid.
8. In addition, there have been no consultations, communications, agreements or arrangements with any competitor regarding the quality, quantity, specifications and conditions or delivery particulars of the products or services to which this bid invitation relates.
9. The terms of the accompanying bid have not been, and will not be, disclosed by the bidder, directly or indirectly, to any competitor, prior to the date and time of the official bid opening or of the awarding of the contract.

I am aware that, in addition and without prejudice to any other remedy provided to combat any restrictive practices related to bids and contracts, bids that are suspicious will be reported to the Competition Commission for investigation and possible imposition of administrative penalties in terms of section 59 of the Competition Act No

89 of 1998 and or may be reported to the National Prosecuting Authority (NPA) for criminal investigation and or may be restricted from conducting business with the public

² Joint venture or Consortium means an association of persons for the purpose of combining their expertise, property, capital, efforts, skill and knowledge in an activity for the execution of a contract.

sector for a period not exceeding ten (10) years in terms of the Prevention and Combating of Corrupt Activities Act No 12 of 2004 or any other applicable legislation.

Name of Bidder	Signature	Date	Position

PA- 40: DECLARATION OF DESIGNATED GROUPS FOR PREFERENTIAL PROCUREMENT

Name of Tenderer EME¹ QSE² Non EME/QSE (tick applicable box)

1. LIST ALL PROPRIETORS, MEMBERS OR SHAREHOLDERS BY NAME, IDENTITY NUMBER, CITIZENSHIP AND DESIGNATED GROUPS.

Name and Surname #	Identity/ Passport number and Citizenship##	Percentage owned	Black	Indicate if youth	Indicate if woman	Indicate if person with disability	Indicate if living in Rural (R) / Under Developed Area (UD) / Township (T) / Urban (U).	Indicate if military veteran
1.		%	<input type="checkbox"/> Yes <input type="checkbox"/> No	<input type="checkbox"/> Yes <input type="checkbox"/> No	<input type="checkbox"/> Yes <input type="checkbox"/> No	<input type="checkbox"/> Yes <input type="checkbox"/> No	<input type="checkbox"/> R <input type="checkbox"/> UD <input type="checkbox"/> T <input type="checkbox"/> U	<input type="checkbox"/> Yes <input type="checkbox"/> No
2.		%	<input type="checkbox"/> Yes <input type="checkbox"/> No	<input type="checkbox"/> Yes <input type="checkbox"/> No	<input type="checkbox"/> Yes <input type="checkbox"/> No	<input type="checkbox"/> Yes <input type="checkbox"/> No	<input type="checkbox"/> R <input type="checkbox"/> UD <input type="checkbox"/> T <input type="checkbox"/> U	<input type="checkbox"/> Yes <input type="checkbox"/> No
3.		%	<input type="checkbox"/> Yes <input type="checkbox"/> No	<input type="checkbox"/> Yes <input type="checkbox"/> No	<input type="checkbox"/> Yes <input type="checkbox"/> No	<input type="checkbox"/> Yes <input type="checkbox"/> No	<input type="checkbox"/> R <input type="checkbox"/> UD <input type="checkbox"/> T <input type="checkbox"/> U	<input type="checkbox"/> Yes <input type="checkbox"/> No
4.		%	<input type="checkbox"/> Yes <input type="checkbox"/> No	<input type="checkbox"/> Yes <input type="checkbox"/> No	<input type="checkbox"/> Yes <input type="checkbox"/> No	<input type="checkbox"/> Yes <input type="checkbox"/> No	<input type="checkbox"/> R <input type="checkbox"/> UD <input type="checkbox"/> T <input type="checkbox"/> U	<input type="checkbox"/> Yes <input type="checkbox"/> No
5.		%	<input type="checkbox"/> Yes <input type="checkbox"/> No	<input type="checkbox"/> Yes <input type="checkbox"/> No	<input type="checkbox"/> Yes <input type="checkbox"/> No	<input type="checkbox"/> Yes <input type="checkbox"/> No	<input type="checkbox"/> R <input type="checkbox"/> UD <input type="checkbox"/> T <input type="checkbox"/> U	<input type="checkbox"/> Yes <input type="checkbox"/> No
6.		%	<input type="checkbox"/> Yes <input type="checkbox"/> No	<input type="checkbox"/> Yes <input type="checkbox"/> No	<input type="checkbox"/> Yes <input type="checkbox"/> No	<input type="checkbox"/> Yes <input type="checkbox"/> No	<input type="checkbox"/> R <input type="checkbox"/> UD <input type="checkbox"/> T <input type="checkbox"/> U	<input type="checkbox"/> Yes <input type="checkbox"/> No
7.		%	<input type="checkbox"/> Yes <input type="checkbox"/> No	<input type="checkbox"/> Yes <input type="checkbox"/> No	<input type="checkbox"/> Yes <input type="checkbox"/> No	<input type="checkbox"/> Yes <input type="checkbox"/> No	<input type="checkbox"/> R <input type="checkbox"/> UD <input type="checkbox"/> T <input type="checkbox"/> U	<input type="checkbox"/> Yes <input type="checkbox"/> No
8.		%	<input type="checkbox"/> Yes <input type="checkbox"/> No	<input type="checkbox"/> Yes <input type="checkbox"/> No	<input type="checkbox"/> Yes <input type="checkbox"/> No	<input type="checkbox"/> Yes <input type="checkbox"/> No	<input type="checkbox"/> R <input type="checkbox"/> UD <input type="checkbox"/> T <input type="checkbox"/> U	<input type="checkbox"/> Yes <input type="checkbox"/> No
9.		%	<input type="checkbox"/> Yes <input type="checkbox"/> No	<input type="checkbox"/> Yes <input type="checkbox"/> No	<input type="checkbox"/> Yes <input type="checkbox"/> No	<input type="checkbox"/> Yes <input type="checkbox"/> No	<input type="checkbox"/> R <input type="checkbox"/> UD <input type="checkbox"/> T <input type="checkbox"/> U	<input type="checkbox"/> Yes <input type="checkbox"/> No
10.		%	<input type="checkbox"/> Yes <input type="checkbox"/> No	<input type="checkbox"/> Yes <input type="checkbox"/> No	<input type="checkbox"/> Yes <input type="checkbox"/> No	<input type="checkbox"/> Yes <input type="checkbox"/> No	<input type="checkbox"/> R <input type="checkbox"/> UD <input type="checkbox"/> T <input type="checkbox"/> U	<input type="checkbox"/> Yes <input type="checkbox"/> No
11.		%	<input type="checkbox"/> Yes <input type="checkbox"/> No	<input type="checkbox"/> Yes <input type="checkbox"/> No	<input type="checkbox"/> Yes <input type="checkbox"/> No	<input type="checkbox"/> Yes <input type="checkbox"/> No	<input type="checkbox"/> R <input type="checkbox"/> UD <input type="checkbox"/> T <input type="checkbox"/> U	<input type="checkbox"/> Yes <input type="checkbox"/> No
12.		%	<input type="checkbox"/> Yes <input type="checkbox"/> No	<input type="checkbox"/> Yes <input type="checkbox"/> No	<input type="checkbox"/> Yes <input type="checkbox"/> No	<input type="checkbox"/> Yes <input type="checkbox"/> No	<input type="checkbox"/> R <input type="checkbox"/> UD <input type="checkbox"/> T <input type="checkbox"/> U	<input type="checkbox"/> Yes <input type="checkbox"/> No

Where Owners are themselves a Company, Close Corporation, Partnership etc, identify the ownership of the Holding Company, together with Registration number
State date of South African citizenship obtained (not applicable to persons born in South Africa)

¹ EME: Exempted Micro Enterprise

² QSE: Qualifying Small Business Enterprise

PA- 40: DECLARATION OF DESIGNATED GROUPS FOR PREFERENTIAL PROCUREMENT

2. DECLARATION:

The undersigned, who warrants that he/she is duly authorized to do so on behalf of the Tenderer, hereby confirms that:

- 1 The information and particulars contained in this Affidavit are true and correct in all respects;
- 2 The Broad-based Black Economic Empowerment Act, 2003 (Act 53 of 2003), Preferential Procurement Policy Framework Act, 2000 (Act 5 of 2000), the Preferential Procurement Regulations, 2017, National Small Business Act 102 of 1996 as amended and all documents pertaining to this Tender were studied and understood and that the above form was completed according to the definitions and information contained in said documents;
- 3 The Tenderer understands that any intentional misrepresentation or fraudulent information provided herein shall disqualify the Tenderer's offer herein, as well as any other tender offer(s) of the Tenderer simultaneously being evaluated, or will entitle the Employer to cancel any Contract resulting from the Tenderer's offer herein;
- 4 The Tenderer accepts that the Employer may exercise any other remedy it may have in law and in the Contract, including a claim for damages for having to accept a less favourable tender as a result of any such disqualification due to misrepresentation or fraudulent information provided herein;
- 5 Any further documentary proof required by the Employer regarding the information provided herein, will be submitted to the Employer within the time period as may be set by the latter;

Signed by the Tenderer

Name of representative	Signature
	Date



public works
& infrastructure

Department:
Public Works and Infrastructure
REPUBLIC OF SOUTH AFRICA

DEPARTMENT OF PUBLIC WORKS

STANDARD LEASE AGREEMENT FOR OFFICE AND FUNCTIONAL ACCOMMODATION

BUILDING NAME AND ADDRESS

CLIENT NAME



public works

Department:
Public Works
REPUBLIC OF SOUTH AFRICA

**STANDARD LEASE AGREEMENT
FOR OFFICE AND FUNCTIONAL ACCOMMODATION**



INDEX

CLAUSE	HEADING	PAGE
1	PARTIES	4
2	DEFINITIONS AND INTERPRETATION	4
3	THE LEASE	7
4	DURATION AND RENEWAL	7
5	THE RENTAL	8
6	USE OF THE PREMISES	9
7	OCCUPATION OF THE PREMISES	9
8	CONDITION OF THE PREMISES AT THE COMMENCEMENT DATE AND AT THE TERMINATION DATE	9
9	FIXTURES	11
10	EXPENSES, MAINTENANCE AND REPAIRS	11
11	OBLIGATIONS OF THE LESSOR	12
12	OBLIGATIONS OF THE LESSEE	14
13	INSURANCE	15
14	FIRE FIGHTING EQUIPMENT AND LIFTS	16
15	ALTERATIONS, ADDITIONS AND IMPROVEMENTS	16
16	DAMAGE TO OR DESTRUCTION OF THE PREMISES	17
17	BREACH	18
18	MANAGEMENT RULES	19
19	LESSORS RIGHT OF ENTRY AND CARRYING OUT OF WORKS	19
20	CESSION, ASSIGNMENT AND SUB-LETTING	19
21	NON-WAIVER	20
22	RIGHT OF FIRST REFUSAL	20
23	SALE OF PREMISES	21
24	WHOLE AGREEMENT	21
25	DOMICILIUM CITANDI ET EXECUTANDI	21
26	WARRANTY OF AUTHORITY	22
27	SEVERABILITY	22
28	SUSPENSIVE CONDITION	23
29	DISPUTE RESOLUTION	23
30	ARBITRATION	24



1 PARTIES

The parties to this agreement are:

the party identified in item 1.1 of Schedule A (hereinafter referred to as the "lessor");

and

the Government of the Republic of South Africa, herein represented by the Director-General of the Department of Public Works or his/ her duly authorised delegate, (hereinafter referred to as the "lessee").

2 DEFINITIONS AND INTERPRETATION

2.1 In this agreement, unless the context indicates otherwise, the following words have the meaning assigned to them hereunder:

"adjustment date" – means the date referred to in item 8 on Schedule A on which date the escalated rate comes into effect;

"the/this agreement" – means the agreement set out in this document together with Schedule A, Schedule B, Schedule C, Schedule D thereto and any other schedules annexed thereto;

"building" – means the entire structure known by the name as set out in item 2.2 of Schedule A and situated on the property set out in item 2.4 of Schedule A;

"calendar day" – means the period from midnight to midnight, inclusive of weekends and public holidays;

"commencement date" – means the date on which this lease commences, which date may not be earlier than the date of occupation OR a month after the lessor has completed the agreed Tenant installations. Such date will be stipulated in item 7 on Schedule A;

"commencement rental" – means the rental payable at the commencement of the lease as is stipulated in Schedule B;

"day" – means any day other than a Saturday, Sunday or official public holiday in the Republic of South Africa;



"escalation rate" – means the percentage mentioned in item 9 on Schedule A, which adjusts the rental on every adjustment date;

"initial lease period" – means the initial period of the lease, as set out in item 3 of Schedule A;

"lessee" – means the Government of the Republic of South Africa, (herein represented by the Director-General of the Department of Public Works or his duly authorised delegate) its successor-in-title and/or its duly authorised employees, agents, intermediaries, representatives and if and to the extent applicable, shall extend to the invitees;

"lessor" – means the party identified in item 1.1 of Schedule A (herein represented by the person identified in item 1.1.4 of Schedule A who by his/her signature hereto warrants that she/he is authorised to sign this agreement on behalf of the lessor), its successor-in-title and/or its duly authorised employees, agents, intermediaries and/or representatives;

"occupant" – the body defined in item 1.2 of Schedule A, being the body which will physically occupy the premises for the duration of the agreement of the lease;

"party / parties" – means the lessee, and the lessor or any of them as determined by the context;

"premises" – means the building and/or the structure and/or the land, or portions thereof, as set out in item 2.1 of Schedule A and a plan of which is attached as Schedule D, which forms the subject of this agreement;

"secondary lease period" – means the period mentioned in item 4 of Schedule A, for which this agreement may be extended by the lessor or the lessee from the date on which the initial lease period expires;

"signature date" – means the date of signature of this agreement by the party which signs last in time;



"termination date" – means the date stipulated in item 10 of Schedule A on which the lease terminate, unless extended for the secondary lease period, as more fully detailed in clause 4 hereof;

"VAT" – means Value-Added Tax in terms of the VAT Act; and

"VAT Act" – means the Value-Added Tax Act (No. 89 of 1991), together with all amendments thereto and all regulations published thereunder from time to time;

- 2.2 The clause headings of this agreement have been inserted for reference purposes only and shall not be taken into account in its interpretation. Unless the context indicates otherwise, words importing the singular shall include the plural, words importing persons shall include natural persons and legal persons and the state and *vice versa*;
- 2.3 If a provision in a definition is a substantive provision conferring rights or imposing obligations on any party, effect shall be given to it as if it were a substantive provision in the body of the agreement, notwithstanding that it is in the definitions clause.
- 2.4 Any reference to an enactment, regulation, rule or by-law is to that enactment, regulation, rule or by-law as at the signature date, and as amended or replaced from time to time.
- 2.5 Where any number of days is prescribed, such number shall exclude the first and include the last day, unless the last day falls on a Saturday, Sunday or public holiday in the Republic of South Africa, in which case the last day shall be the next succeeding day which is not a Saturday, Sunday or public holiday.
- 2.6 The use of the word "including" followed by a specific example/s shall not be construed as limiting the meaning of the general wording succeeding it and the *eiusdem generis* rule shall not be applied in the interpretation of such general wording or such specific example/s.
- 2.7 The expiration or termination of this agreement shall not affect those provisions of this agreement which expressly provide that they will operate after any such expiration or termination or which of necessity must continue to have effect after such expiration or



termination, notwithstanding the fact that the clauses themselves do not expressly provide this.

2.8 In its interpretation, the *contra proferentem* rule of construction shall not apply (this agreement being the product of negotiations between the parties) nor shall this agreement be construed in favour of or against any party by reason of the extent to which any party or its professional advisors participated in the preparation of this agreement.

3 THE LEASE

The lessor hereby leases the premises to the lessee who hires the premises on the terms and conditions set out in this agreement, for occupation by the occupant, it being specifically recorded and notwithstanding anything to the contrary contained in this agreement, that the only persons who are mandated to negotiate, enter into, amend or otherwise agree the terms and conditions of this agreement are lessor and lessee provided that any terms and conditions which are specifically exercisable by the occupant in terms of this agreement, shall be so exercisable despite this clause 3.;

4 DURATION AND RENEWAL

4.1 This agreement shall commence on the commencement date and shall endure for the period as specified in item 3 of Schedule A as the initial lease period.

4.2 Upon the expiry of the initial lease period, the lessee shall have the option of renewing this agreement. The parties will agree on a market related rental for the premises however the annual escalation rate applicable during the secondary lease period shall be limited to headline inflation or the escalation rate applicable during the initial lease period, whichever is the greater;

4.3 All extensions to the lease period in this agreement, and any changes to the terms and conditions of lease during such extended period, shall be concluded in writing and signed by the parties prior to the termination date or expiry of any extended period, as the case may be.



5 THE RENTAL

- 5.1 During the initial lease period, with effect from the commencement date, the monthly rental payable by the lessee to the lessor shall be as specified in Schedule B.
- 5.2 The lease commences with the commencement rental where after the rental shall escalate each year, on each adjustment date, in accordance with the compounded escalation rate as set out in item 9 on Schedule A.
- 5.3 The lessor warrants that the space and parking leased is/are as indicated in the Schedule B. Should it be discovered that the space or parking provided is/are lesser, any amount paid for the non-existent space and/or parking will be recovered as per clause 10.
- 5.4 For leases longer than five (5) years, the rate or tariff agreed between the parties shall be subject to review after the expiry of the fifth year (i.e. de-escalation). The object of the review will be to bring the rates in line with the market, should the parties not agree on the review rate or tariff (as provided in Schedule B), the matter will be resolved as per the Dispute resolution clause beneath.
- 5.5 The rental shall be paid by the lessee to the lessor, monthly in advance on or before the 7th (seventh) day of each and every month.
- 5.6 All payments made by the lessee to the lessor in terms of this agreement, shall be effected by electronic payment directly into the lessor's nominated bank account.
- 5.7 The parties agree that all rentals payable in terms of this agreement shall include VAT where such tax is payable. The lessor shall specify such tax for record and tax purposes separately from the basic rental.
- 5.8 The lessee undertakes to pay all VAT, at the standard rate applicable from time to time, leviable on any amounts payable by the lessee in terms of this agreement.
- 5.9 The lessor shall be liable to pay all rates, taxes, other regulatory amounts and levies in respect of the premises to the relevant authority as well as any expenses and increases.



6 USE OF THE PREMISES

- 6.1 The lessee records that she/he will use the premises for the purpose specified in item 5 of Schedule A and for any legitimate Government purpose. Where the lessee uses the premises for a purpose other than its intended purpose, the onus shall rest on the lessee to obtain and maintain all necessary permits and/or consents for the use of the premises for that purpose.
- 6.2 The lessor hereby warrants and undertakes that the premises are fit for use for the purpose set out in item 5 of Schedule A.
- 6.3 The lessor shall be obliged to obtain such consents and authorisations (excluding trade and other licences) as may be required by competent authorities or title conditions to enable the lessee to use the premises for the purpose referred to in 6.1.

7 OCCUPATION OF THE PREMISES

The lessor warrants the lessee's right to free and undisturbed possession of the premises from the commencement date until termination of this agreement, subject thereto that any delay in taking possession due to avoidable actions or omissions of the lessee, shall not be regarded as a delay on the part of the lessor. The date of occupation shall be the date on which the lessee occupies the premises, which shall also be the date of commencement of the lease

8 CONDITION OF THE PREMISES AT THE COMMENCEMENT DATE AND AT THE TERMINATION DATE

- 8.1 Schedule C contains details of the installations required by the lessee, the party responsible for effecting those installations and the party who bears the costs in respect thereof. Schedule C also contains the obligations, if any, of the lessee in regard to the removal thereof on termination of this agreement. To the extent that any party does not make the installations listed opposite its name in Schedule C, either of the other parties may have such installations made at the reasonable cost thereof and the party which was responsible for such installation shall become liable for such reasonable amount;



8.2 In compliance with the National Building Regulations and Building Standards Act (Act 103 of 1977) as amended, and the Occupational Health and Safety Act (Act 85 of 1993) as amended, and /or any other applicable legislation, the Landlord shall provide the Lessee with the following Certificates of Compliance, where applicable, in respect of the following equipment, prior to occupation of the premises. The lessee shall in writing accept that the lessor has complied with terms of the agreement and that the building is ready and available and ready for use.

Lifts

Electrical Certificate

Firefighting equipment

Gas Installation

Glass certificate

Air-Conditioning Units

8.3 The lessee shall, within 30 days of occupation of the premises, furnish the lessor with three (3) dates and times, which dates must be within twenty-one (21) days of occupation, to convene a meeting to inspect the premises. The lessor shall accept a date, from those furnished, that is suitable to him. At such meeting the parties, including the occupant, shall jointly inspect the premises, so as to ascertain any damage or defect in the premises and the general condition of the premises and to record them in a list which all three parties shall sign.

8.4 The lessor shall within thirty (30) days of such inspection (or such longer period as may be reasonably necessary to repair the defects) repair the defect(s).

8.5 The lessor shall furnish dates and times at least fourteen working (14) days prior to the termination of the agreement for the inspection of the premises after termination of the agreement. Within 14 days after the expiry of this agreement, the lessor shall ensure that the following lists are compiled and delivered to the lessee:

8.5.1 A list of all the items where the parties agree that such items are damaged or defective and that the lessee is liable; and



8.5.2 A list of the items, which are damaged or defective and which in the opinion of the lessor the lessee is liable for, whereas the lessee denies liability.

8.6 The items recorded in the list contemplated in clause 0 shall be replaced as per agreement between the parties. Should the parties fail to reach such an agreement within seven (7) days from the date of delivery of the lists to the lessee, the dispute may by agreement between the parties be referred to an independent professional who shall act as a mediator in an attempt to resolve the dispute.

9 FIXTURES

The parties agree that for the purposes of the interpretation of this clause and of this agreement, fixtures shall refer to movable or immovable fittings installed by the lessee and required for its purposes, such as computer cables and telephone systems. The lessee shall be entitled, at its expense and with the written consent of the lessor, which consent shall not be unreasonably withheld (alternatively, as arranged in Schedule C), to install fixtures (which shall remain the property of the lessee) on the premises; provided that, after the termination of this agreement:

- 9.1 fixtures may be removed by the lessee on condition that the premises are restored to the condition in which they were before the installation of the fixtures, fair wear and tear excepted; or
- 9.2 Should the lessee fail or neglect to remove the fixtures and restore the premises in a substantially similar condition it was on commencement, fair wear and tear excepted, the lessor can remove the fixtures and recover the reasonable costs thereof from the lessee.

10 EXPENSES, MAINTENANCE AND REPAIRS

- 10.1 Subject to 10.3 below, the lessor shall be responsible for and pay all and any expenses in respect of the premises.
- 10.2 The lessor shall be responsible for contracting with the suppliers of utilities to the premises referred to in this clause 10.1 above and shall be directly responsible for payment of these charges and any connection fees and deposits in respect thereof.



10.3 The lessee shall be responsible for and will pay the cost of all electricity, water and/or sewerage consumed on the premises for the duration of this agreement. Electricity and/or water and/or sewerage consumed shall be charged according to the relevant meter reading, provided that the consumption of water, electricity and sewerage in the premises shall be proved *prima facie* by reading of meters or sub-meters and recording same. The lessor shall be responsible for contracting with the suppliers of utilities to the premises referred to in this clause and shall be directly responsible for payment of these charges and any connection fees and deposits in respect thereof.

10.4 In the event of the premises being a portion of a building and it consequently being necessary to determine the lessee's *pro rata* share in respect of maintenance or consumption of necessary services, the *pro rata* share of the lessee, for the purpose of this agreement, shall be determined by calculating the area of the premises as a fraction of the total area of the building.

10.5 Should the lessor fail to pay expenses or to undertake repairs for which the lessor is liable in terms of this agreement, the lessee may remind the lessor in writing, and should the lessor still be in default 30 days after receipt of such reminder (or such longer period which the parties may have agreed upon) the lessee shall be entitled to demand specific performance or to pay such expenses or to undertake such repairs (if and to the extent agreed between the parties) and to recover the amounts thus disbursed from the rental due to the lessor by set off (if and to the extent agreed between the parties) or by legal action. Where the lessee has to attend to the repairs, the lessee will be entitled, but not obliged, to use the Landlord' contractors. A certificate by the lessee of such expenses shall be *prima facie* proof thereof.

10.6 The lessee will also be entitled to recover any undisputed amount overpaid to the lessor in terms of this agreement as per the provision of 10.5.

11 OBLIGATIONS OF THE LESSOR

In addition to any other obligations contained in this agreement, the lessor shall be responsible for:

11.1 The payment of assessment rates, taxes and fixed municipal levies;



- 11.2 Insuring the building as provided for in clause 13 below;
- 11.3 Installation and maintenance of mechanical and fire services equipment, including fire detection equipment, fair wear and tear excepted, as further stipulated in clause 14 hereof;
- 11.4 Landscape maintenance of the premises, if applicable;
- 11.5 Providing, at the lessor's expense, all electric, fluorescent, and incandescent light bulbs required in the premises;
- 11.6 Maintenance of, and for all repairs and replacements becoming necessary from time to time in or to, the roofs and outside walls of the buildings including the maintenance and repair of the structure of the buildings, and all systems, works and installations contained therein;
- 11.7 Maintaining in good order and condition the exterior, roof, gutters and down-pipes of the premises and shall make good any structural defects, other than damage caused by the lessee;
- 11.8 Normal maintenance and repairs (including painting) of both the exterior and interior of the premises, including the cleaning of the exterior of the premises as well as windows, in a high rise building;
- 11.9 Operation (including maintenance and repairs) of the air-conditioning system and the lifts during normal office hours or during such times as may be agreed upon;
- 11.10 Water and electricity consumption to the extent that these are not separately metered for the lessee;
- 11.11 Municipal rates (existing and future) levied on ownership (including rates increases);
- 11.12 Installation and maintenance of the fire extinguishing and fire detection equipment as stipulated in clause 14; and
- 11.13 Replacement of floor covering (carpeting etc.) at the expiry of their agreed lifetime which in the case of carpeting is 5 years from the date of installation;



- 11.14 Submission of valid annual tax certificate/sustain CSD compliance throughout the lease;
- 11.15 Compliance with Occupational Health and Safety and Act (Act No. 85 of 1993);
- 11.16 Compliance with Department of Labour's applicable standards annually – Certification of Occupation;
- 11.17 Quarterly fumigation of the premises. Without prejudice to any rights and/or remedies available to the lessor in terms of this agreement, where any losses, expenses, costs, damages or breakages are attributable to any act or omission of the lessee and/or negligence or wilful intent of the lessee, the lessor shall be entitled to attend to the necessary and recover the reasonable cost thereof from the lessee.
- 11.18 Should the Lessee/occupant be deprived of the full use and enjoyment of the premises through acts or omissions of the lessor e.g. non-functioning air conditioning system, lifts, water shortage etc, the lessee will be entitled to a pro rata reduction in the rental amount.

12 OBLIGATIONS OF THE LESSEE

In addition to any other obligations contained in this agreement, the lessee shall:

- 12.1 Not use the premises or allow them to be used, in whole or part, for any purpose other than that of the business;
- 12.2 Take good and proper care of the interior of the buildings;
- 12.3 Be responsible for all reasonable security, manned or otherwise, necessary to protect the premises;
- 12.4 Not cause or commit any unreasonable nuisance on the premises or cause any annoyance or discomfort to neighbours or the public;
- 12.5 Not unreasonably leave refuse or allow it to accumulate in or about the premises;
- 12.6 Refrain from interfering with the electrical, plumbing, or gas installations or systems serving the premises;



- 12.7 Take all reasonable measures to prevent blockages and obstructions from occurring in drains, sewerage pipes and water pipes serving the premises;
- 12.8 At all times comply with any law, by-law or regulation of the local authority relating to the conduct of its business at the premises and also with the conditions of the title deed under which the premises are held by the lessor;
- 12.9 Not be permitted to place such electrical or other signage on the exterior of the premises without the prior written consent of the lessor;
- 12.10 Forthwith disclose in writing to the lessor details of any act, matter or thing, stored or carried out upon the premises which may affect, vitiate or endanger the fire insurance policy in respect of the property or which may result in an increase of the fire insurance premium;
- 12.11 Undertake domestic cleaning of the interior of the premises, including domestic services such as the provision of toilet paper, soap, towels, etc.; excluding common areas;
- 12.12 Be responsible for the costs of water, electricity and sewerage consumption to the extent that these are separately metered as fully set out in clause 10 above; and
- 12.13 Be responsible for the costs of refuse removal and sanitary services.

13 INSURANCE

- 13.1 The lessor shall comprehensively insure the property and the building, and the lessor's fittings at its replacement value, at the lessor's own risk and cost.
- 13.2 The lessee and the occupant may not after the commencement of the lease do, or allow anything that is contrary to the provisions of the insurance policy, which will cause an increase in the premiums of any insurance policy held by the lessor over the property, provided that the conditions of the insurance policy will be communicated in writing to the lessee from time to time.
- 13.3 Should the lessee knowingly do or cause to be done anything that causes an increase in the premiums of such insurance policy, the lessee will be liable for the increase in the



premiums occasioned by the actions of the lessee. The lessor shall furnish to the lessee proof from the insurer of such increase before any payment shall be due from the lessee.

13.4 The lessor shall not be liable for any damage which the lessee may suffer as a consequence of rain, wind, hail, lightning, fire, earthquake, storm, riots, strikes, actions by enemies of the State or in consequence of the interruption of any facility or service supplies to the premises by third parties, unless such damage could have reasonably been prevented by the lessor.

13.5 The lessor shall not be liable for any accident, injury or damage incurred by the lessee, his employees, agents or visitors, in or near the premises, unless this could have reasonably been prevented on the part of the lessor.

14 FIRE FIGHTING EQUIPMENT AND LIFTS

14.1 The lessor shall be obliged to install, maintain and operate on the premises fire extinguishing and fire detection equipment complying with the National Building Regulations and Building Standards Act (Act No. 103 of 1977) as amended, and/or any other applicable legislation.

14.2 The lessor shall be obliged to maintain the lifts and ensure that regular checks are done in accordance with the Occupational Health and Safety Act (Act No. 85 of 1993) as amended and /or any other applicable legislation.

14.3 The lessor shall provide the lessee with quarterly reports of regular checks done on the fire extinguishers and lifts to ensure safety and security of the occupants of the premises.

15 ALTERATIONS, ADDITIONS AND IMPROVEMENTS

15.1 The lessee shall not make any alterations or additions to any of the buildings, the premises or any part thereof, without the lessor's prior written consent, but the lessor shall not withhold its consent unreasonably to any such alteration or addition. In the event that the lessee does make any such prohibited alterations or additions, it is agreed between the parties that such alterations and/or additions shall be come an immovable part of the respective building or premises to which it is made and shall thus be owned by the lessor who shall not be obliged to compensate the lessee in respect of such alterations and/or



additions. Where the lessee has given its prior written consent to any alteration or addition and such alteration or addition has become an immovable part of the building or premises and has added value to the building or premises, the lessor shall not be obliged to compensate the lessee in respect thereof unless otherwise agreed between the parties prior to such alteration or addition being made.

15.2 Notwithstanding the aforesaid, the lessee shall be entitled to make any non- structural alterations or additions to the interior of the premises without the lessor's prior written consent, provided that the lessee may, on the expiration of this agreement, remove such non-structural alterations or additions as it may have made, provided that simultaneously with any such removal, it reinstates the premises or part of the premises in question, at the lessee's cost, to their same condition (fair, wear and tear excepted) as they were in prior to the carrying out of such alterations or additions.

16 DAMAGE TO OR DESTRUCTION OF THE PREMISES

16.1 In the event of the premises being destroyed and therefore rendered totally unfit for occupation, this agreement shall be terminated automatically unless the destruction of the premises is due to the wilful intent or negligence of the lessee and/or occupant.

16.2 In the event of the premises being damaged and remaining partially suitable for the purposes of the lessee, the parties shall be entitled to terminate this agreement by thirty (30) days' notice in writing given to the other party within thirty (30) days after such destruction or damage.

16.3 Should no notice in terms of 16.2 above be given, then this agreement shall continue and the lessor shall be obliged to proceed expeditiously with the work of rebuilding the premises. Should the parties continue with the agreement, the lessee shall be entitled to a reduction in rental to the extent to which the lessee is deprived of the full and beneficial use and occupation of the premises until such time as the premises have been rebuilt or re-instated.

16.4 Should there be any dispute as to the extent to which the premises have been damaged and/or the extent to which the premises are unfit for occupation and capable of being



17.1.4 in addition to the ordinary factors which affect the validity of a contract, the parties agree that any unlawful act committed by the lessor which was material in the conclusion the contract will impair the validity of this contract warranting the lessee to terminate this agreement.

17.2 Should either party breach any obligations in terms of this agreement and fail to remedy such breach within 30 (thirty) days of written demand from the aggrieved party to do so, or such longer period as may be reasonable in the circumstances, the aggrieved party shall be entitled to cancel this agreement or claim specific performance, in either case, without prejudice to the aggrieved party's rights to claim damages from the offending party.

18 MANAGEMENT RULES

The lessee shall comply with all management rules as may be prescribed by the lessor from time to time provided that they are fair, reasonable and justifiable.

19 LESSORS RIGHT OF ENTRY AND CARRYING OUT OF WORKS

The lessor's representatives, agents, servants and contractors may at reasonable times and on reasonable notice (save for the in the event of an emergency), without thereby giving rise to any claim or right of action on the part of the lessee or the occupant of the property or any part thereof, enter the property or any of the buildings in order to inspect them, to carry out any necessary repairs, replacements, or other works, or to perform any other lawful function in the *bona fide* interests of the lessor or the lessee or the occupant, but the lessor shall ensure that this right is exercised with due regard for and a minimum of interference with the beneficial enjoyment of the property by those in occupation thereof, and provided further that such rights will be exercised subject to the lessee's specific security requirements relating to the physical security of the property.

20 CESSION, ASSIGNMENT AND SUB-LETTING

The lessee shall not, except with the prior written consent of the lessor, which shall not be unreasonably withheld:



- 20.1 cede or assign all or any of the rights and obligations of the lessee under this agreement; or
- 20.2 sublet the premises in whole or in part; or
- 20.3 give up possession of the premises or any portion thereof to any third party.

21 NON-WAIVER

- 21.1 Neither party shall be regarded as having waived, or been precluded in any way from exercising, any right under or arising from this agreement by reason of such party having at any time granted any extension of time for or having shown any indulgence to the other party with reference to any payment or performance hereunder, or having failed to enforce, or delayed in the enforcement of any right of action against the other party.
- 21.2 The failure of either party to comply with any non-material provision of this agreement shall not excuse the other parties from performing their obligations hereunder fully and timeously.

22 RIGHT OF FIRST REFUSAL

- 22.1 The Lessor hereby grants to the Lessee and the Lessee hereby accepts the right of first refusal to purchase the property.
- 22.2 Pursuant to the right granted by the Lessor in favour of the Lessee in 22.1, the Lessor shall not dispose of any part or whole of the property at any time except in accordance with the following circumstances;
 - 22.2.1 if the Lessor intends to so dispose, the Lessor shall deliver to the Lessee a written notice offering ("the offer notice) so to dispose, to the Lessee at a consideration (which shall sound in money in South African currency) and on such terms as may be stipulated in the offer notice; and
 - 22.2.2 the Lessee may, at any time within 60 days after the receipt of the offer notice, accept it by giving written notice to the Lessor to that effect.
- 22.3 If the Lessee does not accept the offer within the aforesaid period, the Lessor may dispose of the property on terms no more favourable than the terms contained in the offer



notice within a period of 90 (ninety) days after the Lessee has rejected the offer, whereafter the Lessor shall again be obliged to follow the procedure in clause.

22.4 Should the Lessee not exercise its right of first refusal in relation to the property or in relation to any rights thereto or pursuant thereto, the relevant acquirer shall acquire the property free of the right of first refusal contained in this clause.

23 SALE OF PREMISES

23.1 Transfer of the ownership of premises from the Lessor to a third party pursuant to a sale thereof shall not in any way affect the validity of this agreement. It shall accordingly, upon registration of transfer of the premises into the name of the purchaser, remain of full force and effect save that the purchaser shall be substituted as Lessor and acquire all rights and be liable to fulfil all the obligations which the Lessor, as the Lessor, enjoyed against or was liable to fulfil in favour of the Lessee in terms of the this agreement.

23.2 Nothing shall prevent the Lessor from advertising the premises as “for sale” or as “to let” as long as it does not disturb the Lessee in its use and enjoyment of the premises and any activities which the Lessor undertakes are undertaken on reasonable notice to the occupant.

24 WHOLE AGREEMENT

24.1 This is the entire agreement between the parties inclusive of all bid/tender documents.

24.2 Neither party relies, in entering into this agreement, on any warranties, representations, disclosures or expressions of opinion, which have not been incorporated into this agreement as warranties or undertakings.

24.3 No variation, alteration, or consensual cancellation of this agreement shall be of any force or effect unless reduced to writing and signed by the duly authorised representatives of both parties.

25 DOMICILIUM CITANDI ET EXECUTANDI

25.1 The parties respectively choose as *domicilium citandi et executandi* and as the address for the serving of notices the address appearing underneath their names in Schedule A



(and the lessor is explicitly barred from serving such notices on officials and offices in the Regions/Provinces).

25.2 Any notice given by one of the parties to the other ("the addressee") which:

26.2.1 is delivered by hand to a responsible person during ordinary business hours at the physical address chosen as the addressee's *domicilium citandi et executandi* shall be deemed to have been received by the addressee on the date of the delivery, unless the contrary is proved;

26.2.2 is posted by prepaid registered post from an address within the Republic of South Africa to the addressee at the addressee's *domicilium citandi et executandi*, shall be deemed to have been received by the addressee on the tenth (10th) business day of the date of posting unless the contrary is proved; or

26.2.3 is emailed to the chosen email address, during ordinary business hours shall be presumed to have been received by the addressee at the time of transmission of the email, alternatively, if not emailed during normal business hours then at twelve o' clock on the 1st business day following the day on which it was emailed.

25.3 Either party shall be entitled, on 14 days' notice to the other, to change the address of his *domicilium citandi et executandi*.

26 WARRANTY OF AUTHORITY

The parties hereby warrant that each of them has the power, authority and legal right to sign and perform this agreement and that this agreement has been duly authorised by all necessary actions of its directors, to the extent applicable, and constitutes a valid and binding obligation on it in accordance with the terms thereof.

27 SEVERABILITY

Any provision in this agreement which is or may become illegal, invalid or unenforceable in any jurisdiction affected by this agreement shall, as to such jurisdiction, be ineffective



to the extent of such prohibition or unenforceability and shall be treated *pro non scripto* and severed from the balance of this agreement, without invalidating the remaining provisions of this agreement or affecting the validity or enforceability of such provision in any other jurisdiction.

28. SUSPENSIVE CONDITION

Where the standard Tenant Installation allowance by the Lessor is not sufficient to cover all the required Tenant Installation, this lease contract is subject to the availability of the necessary additional funds/budget on the part of the lessee.

29. DISPUTE RESOLUTION

In the event of a dispute, disagreement or claim arise between the parties (called hereafter "the dispute") connected with or concerning this Agreement, the parties shall first endeavour to resolve the dispute by negotiation in good faith. This entails that the one party invites the other in writing to a meeting in an attempt to resolve the dispute within 7 (seven) days from date of the written invitation.

If the dispute has not been resolved by such negotiation, the parties shall submit the dispute to mediation to be administered by a property specialist or lawyer nominated by the parties by agreement or alternatively by the relevant professional body of property specialist or Law Society or Bar Council.

Should the parties fail to resolve the dispute through negotiation and/or mediation, the dispute shall be referred to arbitration, only if the parties agree thereto, in which event the arbitration clause hereunder shall apply.

30. ARBITRATION

If either Party to this Agreement is unwilling to accept mediation or is unwilling to accept the opinion expressed by the mediator, then either Party may require that the dispute be referred to arbitration.



The dispute will be referred to Arbitration by written notice delivered to the other, within 20 days of the declaration of the dispute if there is no mediation or within 20 days of the issue of the mediator's opinion if mediation takes place.

Such arbitrator shall be selected by agreement between the Parties, or if no agreement is reached after 10 days from deliberation on the identity of the Arbitrator; it is agreed that the arbitrator will be nominated on request of either of the party by the president of the Arbitration Foundation of South Africa, or its successor-in-title.

The arbitrator shall have power to open up, review and revise any certificate, opinion, decision, requisition or notice relating to all matters in dispute submitted to him and to determine all such matters in the same manner as if no such certificate, opinion, decision, requisition or notice had been issued. The arbitrator shall be entitled to make award, including an award for specific performance, an interdict, damages or otherwise as he in his discretion may deem fit and appropriate.

If a request is made by the arbitrator for a document or any item to be submitted, such document or item must be submitted within ten (10) days of the request.

The arbitration shall be conducted in the English language at _____ or such other place as the Parties may agree on in writing.

The costs of and incidental to the award shall be in the discretion of the arbitrator, who may determine the amount of the costs, and shall direct by whom and to whom and in what manner they shall be borne and paid.

The award of the arbitrator shall be final and binding on the Parties though subject to review on any of the usual grounds for review. Any Party shall be entitled to apply to the Courts to have such award made an order of court if the party concerned fails to heed to the terms of the award. Nothing in this clause shall prevent either Party seeking urgent relief in the High Court of South Africa and for this purpose, the Parties consent to the exclusive jurisdiction of the High Court of South Africa.



SIGNED AT..... ON THIS THEDAY OF..... 20.....

WITNESSES

1.
FULL NAME AND SIGNATURE

2.
FULL NAME AND SIGNATURE

.....
SIGNATURE OF LESSOR / REPRESENTATIVE

.....
FULL NAMES

Duly authorised as per attached resolution.

SIGNED AT..... ON THIS THEDAY OF..... 20.....

WITNESSES

1.
FULL NAME AND SIGNATURE

2.
FULL NAME AND SIGNATURE

.....
SIGNATURE OF LESSEE / REPRESENTATIVE

.....
FULL NAMES

.....
CAPACITY

Duly authorised as per Departmental delegation dated



SIGNED AT..... ON THIS THEDAY OF..... 20.....

.....

SIGNATURE OF OCCUPANT

.....

FULL NAME

.....

CAPACITY

Duly authorised as per Departmental delegation dated



SCHEDULE C

The lessor shall issue relevant Certificates of Compliance before occupation of the premises, failing which the occupant is not obliged to take occupation of the premises and the Lessee is not obliged to pay any rental amounts.

SCHEDULE C1: TENANT INSTALLATIONS

INSTALLATIONS	PARTY TO REPORT	PARTY TO PAY	DURATION / FREQUENCY
Space planning and refurbishing requirements / needs	Lessee	Lessee	Upon signing of lease agreement and before date of occupation
Project Execution Plan	Landlord	Landlord	Before date of occupation
Installation of air-conditioning (system or split units) or Repair of the existing one to excellent functioning condition.	Landlord	Landlord	Before date of occupation
Installation of the disability toilet to comply with Occupational Health and Safety requirements.	Landlord	Landlord	Before date of occupation
Installation of fire equipment and maintenance	Landlord	Landlord	Before date of occupation
Installation of carpets / ceramic tiles in some offices and installation of ceramic tiles in all common areas	Landlord	Landlord	Before date of occupation
Install ramps for people with disabilities / upgrade ablution facilities	Landlord	Landlord	Before date of occupation
Install blinds and maintenance of blinds	Landlord	Landlord	Before date of occupation
Emergency assembly point needs to be provided and marked with signage	Landlord	Landlord	Before date of occupation
Standard plug points	Landlord	Landlord	Before date of occupation

SCHEDULE C2: FUNDED MAINTENANCE PLAN

INSTALLATIONS	RESPONSIBLE PARTY	PAYEE	DATE OF COMPLETION
Submission of funded Maintenance Plan. (As part of the Lease Agreement and initialled by Representatives of both Lessor and Lessee).	Landlord	Landlord	Before signing of the lease agreement
General maintenance of the building	Landlord	Landlord	Before date of occupation
Ensure functional lifts	Landlord	Landlord	Before date of occupation
Ensure that all roof leaks are repaired.	Landlord	Landlord	Before date of occupation
Replace or replace gutters and down pipes	Landlord	Landlord	Before date of occupation
Repair emergency stair cases	Landlord	Landlord	Before date of occupation
Replace lights and fittings (where necessary)	Landlord	Landlord	Before date of occupation
Replace or repair ceiling	Landlord	Landlord	Before date of occupation
Repair steps and stairs of emergency staircases	Landlord	Landlord	Before date of occupation
Service Air conditioners	Lessor	Lessor	Before date of occupation

SCHEDULE C3: UPGRADING PLAN

INSTRUCTIONS	PASTOR OR OFFICER	PARTY TO PAY	DATE OR EVENT
<p>Upgrade Plan required.</p> <p>Note: Upgrade plan required where complaints have been tendered about the state of the building.</p> <p>For 9 years /11 months lease period, upgrade plan is compulsory regardless of complaints lodged about the state of the building.</p>	Landlord	Landlord	Before lease agreement is signed.
<p>Submitted upgrade plan must be executed.</p> <ul style="list-style-type: none"> • Structural upgrade • Mechanical installations and lifts upgrade or replacement • Electrical installations • Plumbing upgrades 	Landlord	Landlord	<p>Within 12 months of signing lease agreement.</p> <p>Failure to do so will result in termination of the lease agreement.</p>
<p>Appropriate cost for the upgrade plan.</p> <p>Amount: R.....</p>	Landlord	Landlord	Committed upgrade must be completed during tenant installation for new leases.



sassa
CELEBRATING 10 YEARS
#SASSA10

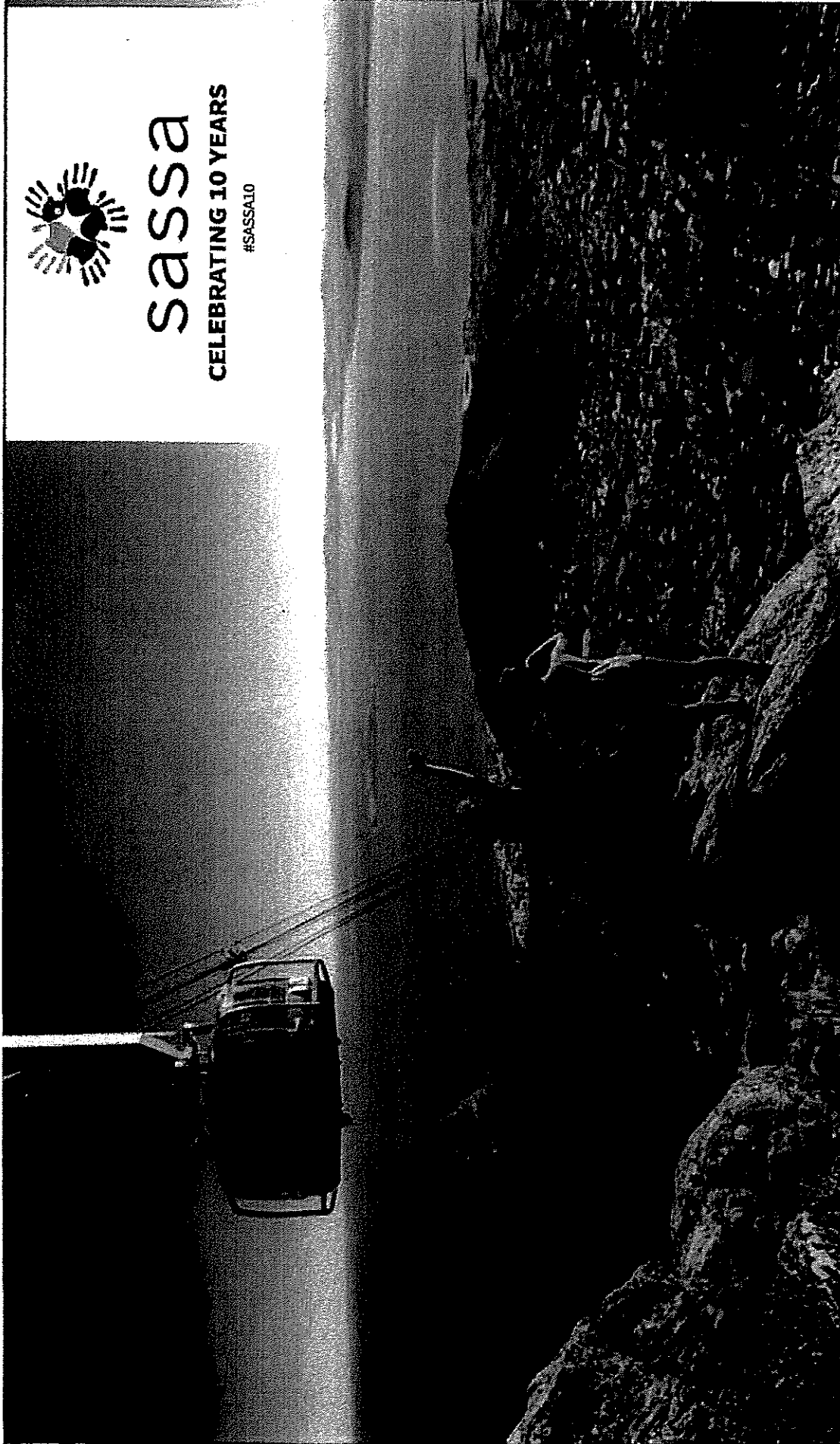

sassa

SASSA
WESTERN CAPE CORPORATE
INTERIOR DESIGN GUIDELINES

OUR VISION

To ensure a better life for all South Africans by providing world class social security services

OUR MISSION

To administer quality social services, cost effectively and timously using appropriate best practice by:
Developing and implementing policies, programmes and procedures for an effective and efficient social grants administration system;







Paying the right amount, to the right person, at the right time and at the most convenient place that he or she may choose;

Delivering innovative, cost effective and efficient services to individuals, their families and community groups via multiple and easy access channels using modern technology



South Africa Social Security Agency
 Compensate Welfare Childcare

PRINCIPAL COLOURS AND LOGOS

<p>SASSA RED</p>  <p>PANTONE® 1795 C</p>	<p>SASSA BLUE</p>  <p>PANTONE® 2141 C</p>	<p>SASSA YELLOW</p>  <p>PANTONE® 1080</p>
<p>PROCESS CMYK</p> <p>Cyan 0 Magenta 34 Yellow 100 Black 0</p>	<p>PROCESS CMYK</p> <p>Cyan 100 Magenta 44 Yellow 0 Black 0</p>	<p>PROCESS CMYK</p> <p>Cyan 0 Magenta 30 Yellow 100 Black 0</p>
<p>SASSA GREEN</p>  <p>PANTONE® 3415 C</p>	<p>SASSA BLACK</p>  <p>PANTONE® 2125 C</p>	<p>SASSA BLACK</p>  <p>PANTONE® 2655 BLACK</p>
<p>PROCESS CMYK</p> <p>Cyan 100 Magenta 0 Yellow 77 Black 22</p>	<p>PROCESS CMYK</p> <p>Cyan 41 Magenta 8 Yellow 8 Black 100</p>	<p>PROCESS CMYK</p> <p>Cyan 0 Magenta 0 Yellow 0 Black 70</p>

The Sassa colour palette is derived from our logo. Use specified as above. Convert CMYK to RGB when required. But it is preferred that you use the Pantone palette for consistency. Let us know in writing to our specified colour palette specifications. We are the only authorised reproduction of our logo. Any other use of our logo without our permission is prohibited. We are not responsible for any damage or loss of data or information that may be caused by the use of our logo.

PRINCIPAL COLOURS AND LOGOS



sassa
SOUTH AFRICAN SOCIAL SECURITY AGENCY

South African Social Security Agency
Corporate Interior Guidelines

STANDARDISED CORPORATE COLOURS



PROCESS CMYK

Cyan 0
Magenta 37
Yellow 26
Black 0



PROCESS CMYK

Cyan 0
Magenta 68
Yellow 29
Black 0



PROCESS CMYK

Cyan 0
Magenta 35
Yellow 24
Black 20



PROCESS CMYK

Cyan 0
Magenta 43
Yellow 15
Black 15



PROCESS CMYK

Cyan 0
Magenta 37
Yellow 65
Black 44

The secondary colour palette uses solid black and complement or primary color colors. We would like to receive a firm attachment, screenshot and appropriate approvals in our office environment. The color that we have looked for our office brand is a warm silver color - Pantone 498C as the overall wall color complemented by a more vibrant Pantone 141C for the walls of some of the office.

10



sassa
SOUTH AFRICAN SOCIAL SECURITY AGENCY

South African Social Security Agency
Corporate Interior Guidelines

FLOORS TOILETS



All toilets are to be tiled with 300 x 300 x 25 Matte/Hex Balsa (March Pastime) 450C3. The tiles must be laid in accordance with the manufacturer's instructions. The types of tiles are subject to change without notice. Tiles must be laid in a staggered pattern. Tiles must be laid in a staggered pattern. Tiles must also match the floor tile of the various areas. Tiles are a very important part of our planned colour. Balsa and dark brown tiles are placed on the wall and combine for a dramatic contrast in tone of different areas.

SKIRTINGS



75mm Natural enameled aluminium skirting to Grey-well portion of 75mm Maple skirting painted with high gloss enamel paint, colour C-37, Timber skirting, which is visible to our customers, has a very important role to play in the overall appearance of the building. The skirting must be installed in a staggered pattern. Tiles are a very important part of our planned colour. Balsa and dark brown tiles are placed on the wall and combine for a dramatic contrast in tone of different areas.

No skirting to toilets.

153



sassa

South African Social Security Agency
Corporate Interior Guidelines

TABLE



All doors are to be 0.813 x 2032, 44mm thick laminated doors hung in standard sized fittings and fitted with two mortice locks with anti chrome plated handles. Steel door fittings to be painted high gloss enamel paint CS7. Doors to be painted eggshell enamel paint E30-7.

SOUTH AFRICAN SOCIAL SECURITY AGENCY CORPORATE INTERIOR GUIDELINES

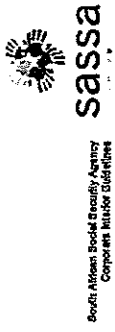

PROJECTING SIGNS

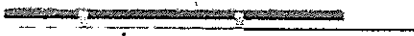

Reception 

SOUTH AFRICAN SOCIAL SECURITY AGENCY CORPORATE INTERIOR GUIDELINES

Wall projecting signs typically appear in prominent positions where they can be seen by members of the public. They also carry directional arrows and content that informs visitors and staff. Wall projecting signs are situated at right angles to the mounting surface.



BUSINESS HOURS DECALS

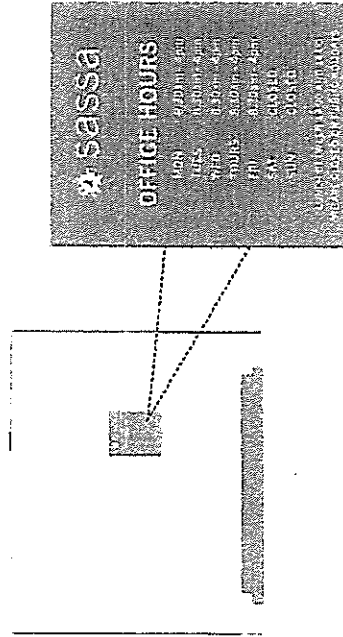

The business hours decal appears on the entrance doors

SOUTH AFRICAN SOCIAL SECURITY AGENCY CORPORATE INTERIOR EXPERTS



South African Social Security Agency
Companie's Inkeleto Qabehisa

INDICATORS

reception enquiries enrolment

reception

reception

SOUTH AFRICAN SOCIAL SECURITY AGENCY COMPANIE'S INKELETO QABEHISA

A list of approved suppliers are available from the Department Head Office.

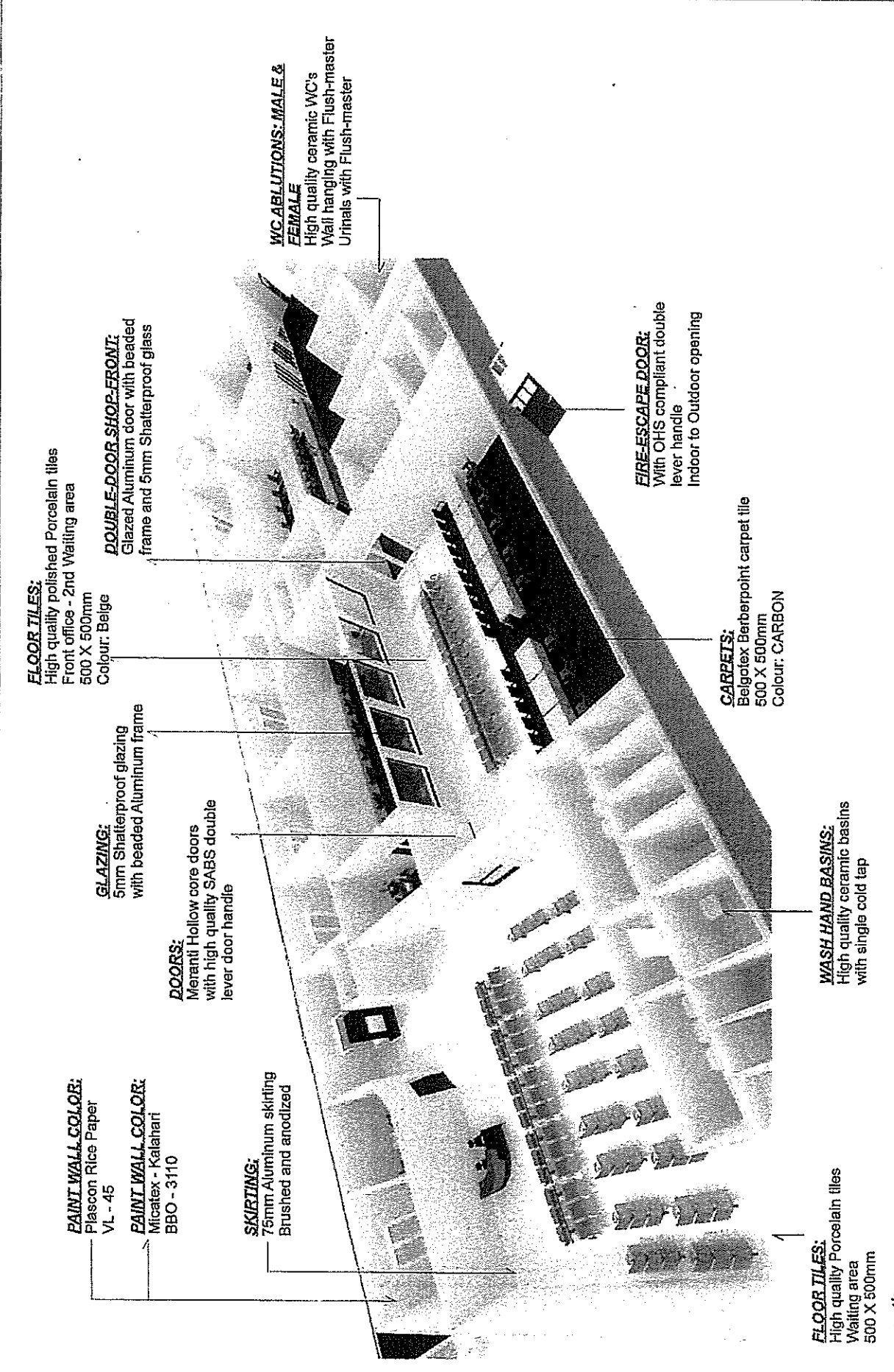

FLOOR TILES:
High quality polished Porcelain tiles
Front office - 2nd Waiting area
500 X 500mm
Colour: Beige

DOUBLE-DOOR SHOP-FRONT:
Glazed Aluminum door with beaded frame and 5mm Shatterproof glass

GLAZING:
5mm Shatterproof glazing with beaded Aluminum frame

DOORS:
Meranti Hollow core doors with high quality SABS double lever door handle

PAINT WALL COLOR:
Plascon Rice Paper VL - 45

PAINT WALL COLOR:
Micaltex - Kalahari BBO - 3110

SKIRTING:
75mm Aluminum skirting Brushed and anodized

WC ABLUTIONS: MALE & FEMALE
High quality ceramic WC's Wall hanging with Flush-master Urinals with Flush-master

FIRE-ESCAPE DOOR:
With OHS compliant double lever handle
Indoor to Outdoor opening

CARPETS:
Belgotex Berberpoint carpet tile
500 X 500mm
Colour: CARBON

WASH HAND BASINS:
High quality ceramic basins with single cold tap

FLOOR TILES:
High quality Porcelain tiles
Waiting area
500 X 500mm

DRAWINGS PREPARED BY: Mr. Rafiek Hantlebe Call: 072 11 666 37		PROJECT DESCRIPTION: NEW SASSA PAARL LOCAL OFFICE PROJECT 20 MAY 2019		PROJECT ADDRESS: BROADWAY STREET PAARL EAST		SHEET TITLE:		SCALE:	DATE: 2019-10-07	K-6
---	--	---	--	---	--	--------------	--	--------	---------------------	-----



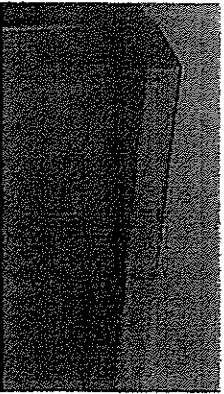

SKIRTING:
75mm Aluminum skirting
Brushed and anodized

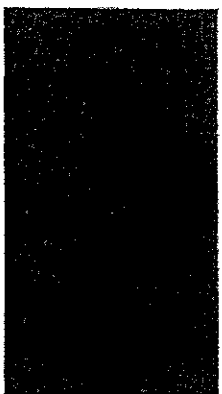

CARPETS:
Belgotex Berberpoint carpet tile
500 X 500mm
Colour: CARBON

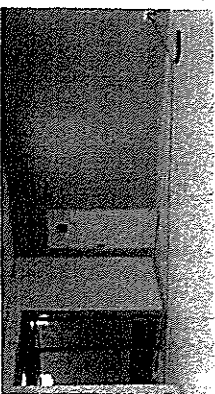

PAINT WALL COLOR:
Micatex - Kalahari
BBO - 3110

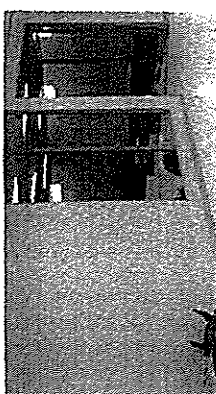

PAINT WALL COLOR:
Plascon Rice Paper
VL - 45

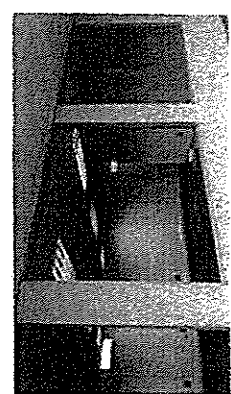

GLAZING:
5mm Shatterproof glazing
with beaded Aluminum frame

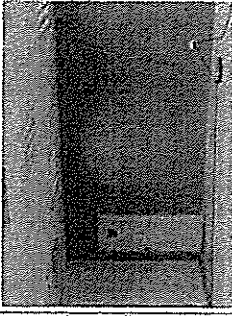

DOORS:
Meranti Hollow core doors
with high quality SABS double
lever door handle



GLAZING:
Glazing bead to
Aluminum frame

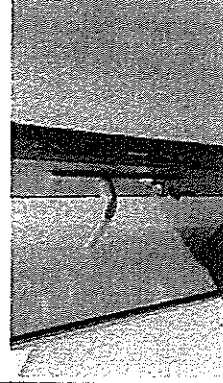

DOOR HANDLE:
High quality brushed
Aluminum handle

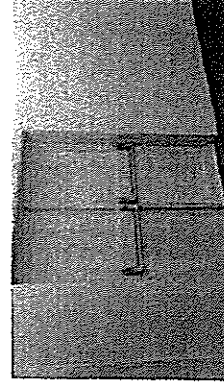

FIRE-ESCAPE DOOR:
With OHS compliant double
lever handle
Indoor to Outdoor opening

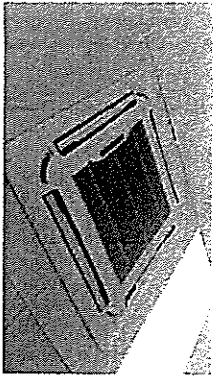
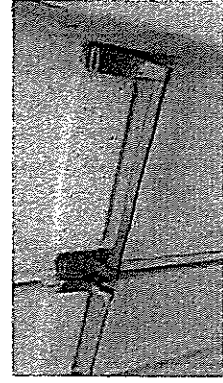

AIR-CONDITIONS:
Total Btu to be determined
by area to be cooled
by Architect

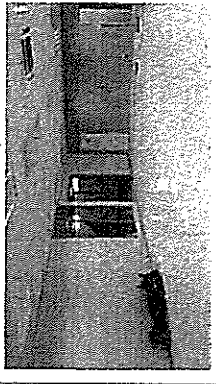

FLOOR TILES:
High quality polished Porcelain tiles
Waiting area: Color Beige
500 X 500mm

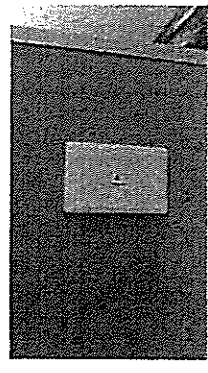

LIGHT SWITCH:
Modern smooth cover
with high quality switch

DRAWING PROVIDED BY: Mr Toleak Hendricks Cell: 072 17 086 37		PROJECT DESCRIPTION: NEW SASSA PAARL LOCAL OFFICE PROJECT 20 MAY 2019		PROJECT ADDRESS: BROADWAY STREET PAARL EAST		STREET TITLE:		NO.:	DESCRIPTION:	DATE:	SCALE:	DATE:	K-7
												2019-10-07	



sassa



KITCHEN & PAUSE AREA:
Fully fitted kitchen with postform tops and soft closing drawers



KITCHEN & PAUSE AREA:
Kitchen includes wall units for plates and cups
Tiled splash-back to underside of wall units

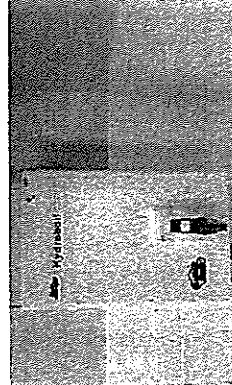

HYDRO-BOIL:
Instant hot water directly over double stainless sink

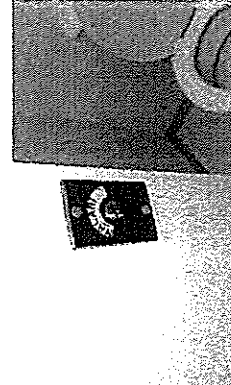

ABLUTION DOOR INDICATOR LOCK:
Vacant/ Occupied



sassa

DRAWINGS PROVIDED BY:
Mr Farook Hendricks
Call: 072 17 656 37

PROJECT DESCRIPTION:
NEW SABBA PAARL LOCAL OFFICE PROJECT
20 MAY 2019

PROJECT ADDRESS:
BROADWAY STREET
PAARL EAST

SHEET TITLE:

SCALE:
DATE: 2019-10-07

K-8



MALE & FEMALE ABLUTIONS:
2 - 3 single basins with cold water supply
1 full mirror
Splash-back tiles and walls painted

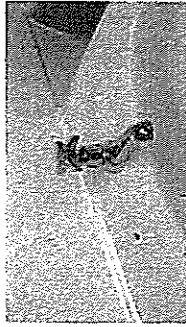

CERAMIC BASINS:
High quality basins with single tap



EXTRACTOR FANS:
All ablutions to have fans

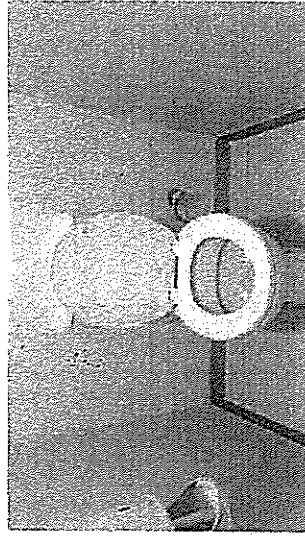

WASH CLOSET (W.C.):
Quality ceramic wc with wood seat cover and brass bolts
Push button flush system
Toilet roll holder

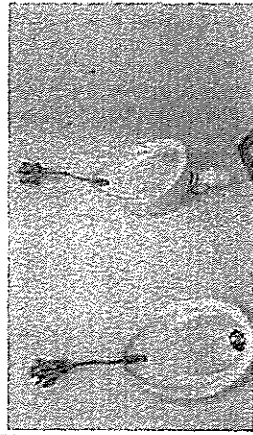

MALE URINALS:
Ceramic urinals with Flushmaster system

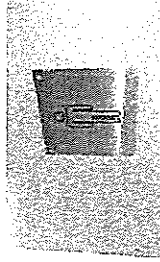

DOOR SIGNAGE:
Aluminum brushed finish

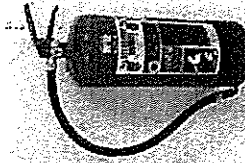
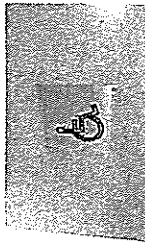

FIRE EXTINGUISHERS:
Fully maintained F/E located to OHS standards

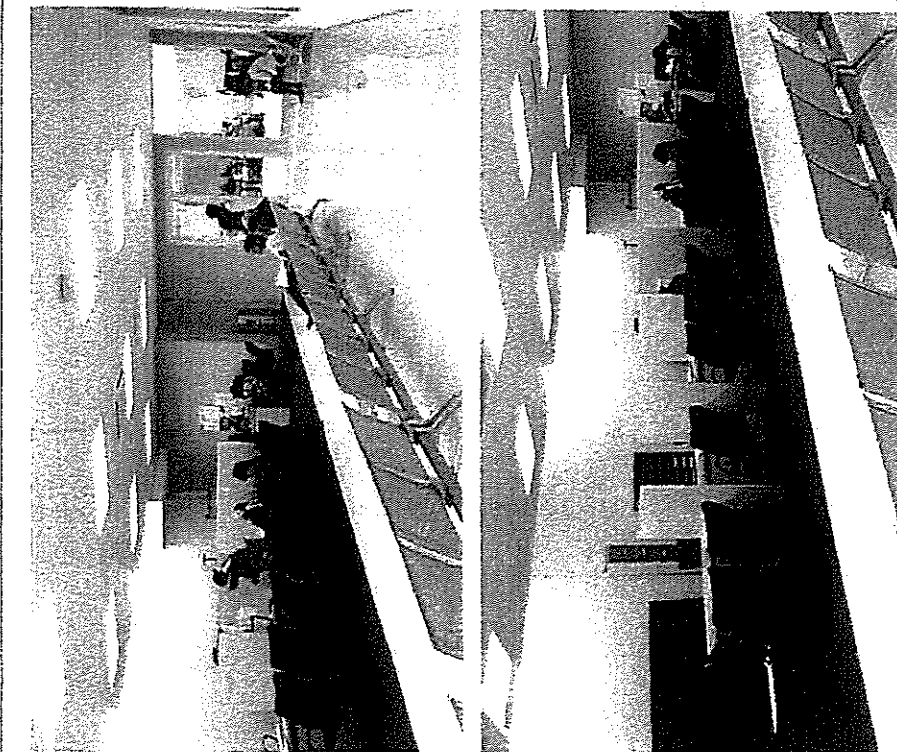

SASSA FRONT OFFICE:
Front office with Airport chairs and
Client service desks

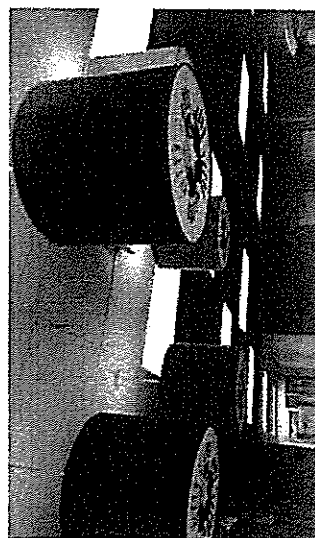
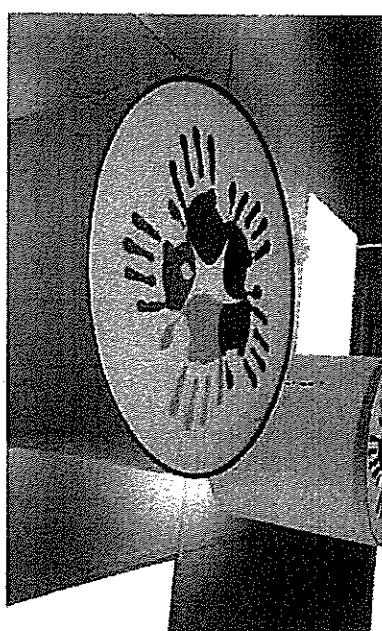
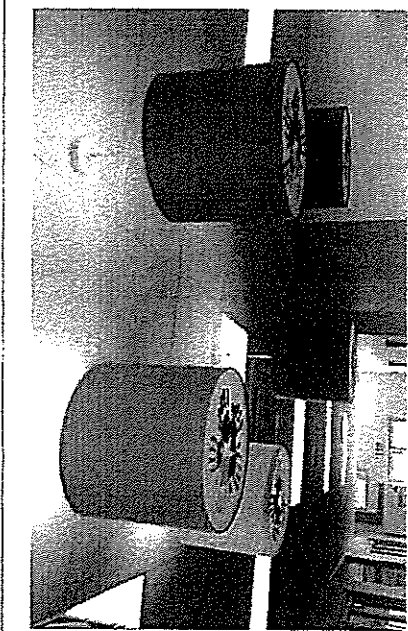

LANTERNS:
Customized SASSA Lanterns

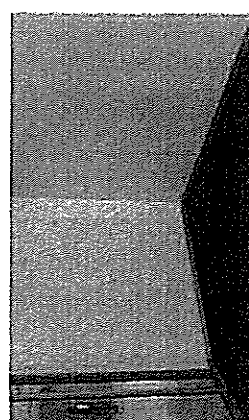
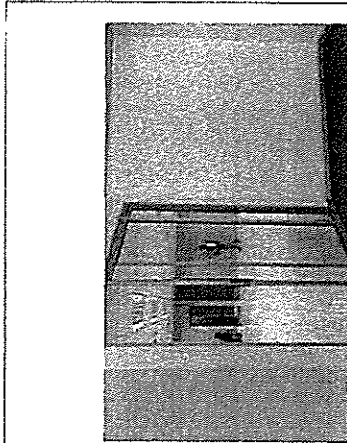

SAPO OFFICE:
Fully fitted integrated SAPO office



DESIGNED BY:
Mr Ruteek Handricha
Cell: 072 17 686 37

PROJECT DESCRIPTION:
NEW SASSA PAARL LOCAL
OFFICE
PROJECT
20 MAY 2019

PROJECT ADDRESS:
BROADWAY STREET
PAARL EAST

SHEET TITLE:

No.	DESCRIPTION	BY	DATE

SCALE:

DATE:
2019-10-07

K-10

103

TENANT INSTALLATION REQUIREMENTS FOR ICT INFRASTRUCTURE

SECTION B: ICT Building Requirements

Main DB Board

The Main DB Board supplied to SASSA needs to be of adequate size to accommodate the ICT Requirement. As a guide, ICT provides the following power to each desk as a minimum:

- 1 x Dedicated Power (Red)
- 1 x Standard Power (White)

A 25/30amp Circuit Breaker is installed per every 5 power plugs provided.

Server Room Power

The Server Room makes use of re-articulated Power to power the Server/Switch Cabinet, as such it is required that the following SUB-DB be installed in the Server Room with the circuit feed from the Main DB Board being clearly marked:

- 1 x Single Row 12-way Sub-DB Board, colour white
- 1 x Triple Pole Main Circuit Breaker (if 3-Phase Power)
- 1 x Double Pole Main Circuit Breaker (if 2-Phase)
- 1 x Wire Tray to be provided for

In addition, an Earth Bar in line with SANS 10142-1 standard needs to be provided for in the Server Room. This will either originate from the Main DB Board or from a new Earth Spike:

1 x Single Copper Earth Bar with 6mm Green/Yellow Insulated Cable, pre-drilled (not to exceed 300mm long x 60mm wide x 10mm thick)

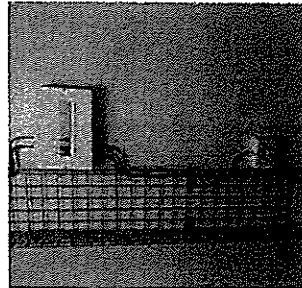

- ICT will indicate location of both Sub-DB and Earth Bar

Trunking

As all Desk Areas and Multi-Function Units require Power and Network Connectivity, adequate trunking needs to be provided. The following Standard applies:

- Execu-duct Dual Power-skirting - Grey

Trunking needs to be flushed mounted and adequately secured to the surface it is being mounted against. Trunking to include all fittings, brackets and end-caps

- NO Power, Network or Telephony mounts to be provided

Cable Conduits/Routes

Cabling Conduits/Routes are required to enable SASSA ICT to provide the required Power and Network Connectivity. The following is thus required:

- Cable Trays in the Ceiling that provide a Route to the Server Room as well as to each of the Drop Points
- 2 x 25mm PVC Pipes (empty) at each of the drop-points to ensure Electrical and Network Cables can be run into the Execu-duct Trunking



- Cable Trays are to be of adequate width to separate Electrical and Data Cables

Server/Switch Room Security

To ensure that the Server/Switch Room is secure, the following is required

- Solid Door
- 3-way Lock
- Security Gate outside of the Server/Switch Room Door

NS

Server/Switch Room Air-Conditioning

If no central air-conditioning is provided for, SASSA ICT Requires adequate cooling is installed within its Server/Switch Room. The following standard applies:

- 18,000 BTU Split Unit – Inverter Unit
- BTU Rating may be changed in accordance to size of the Server/Switch Room

Server/Switch Room Fire/Smoke Detector

If no Fire/Smoke Detection System is in place, a Fire/Smoke Detector is required to be installed within the Server/Switch Room with an indicator light outside the Server Room Door that will be visible by staff if the system is triggered.

Server/Switch Room Floor

The Server/Switch Room floor needs to be covered by a certified heavy-duty Anti-Static/Anti-Dust floor tile that is rated for Server Rooms. The preferred colour is grey but if needed, the colour could match the floor/carpet tiles of the office for aesthetic purposes

12

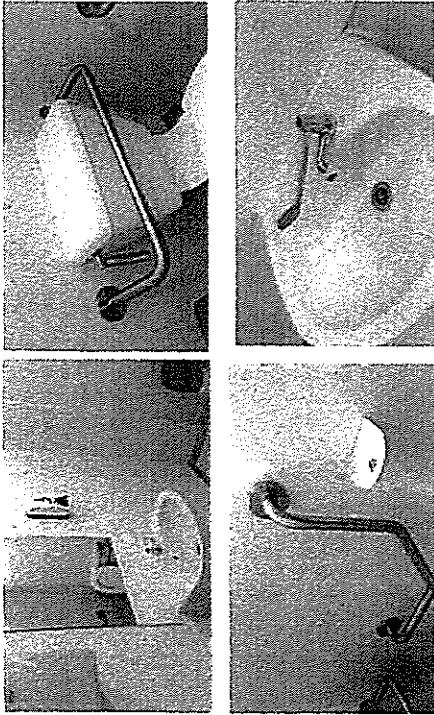
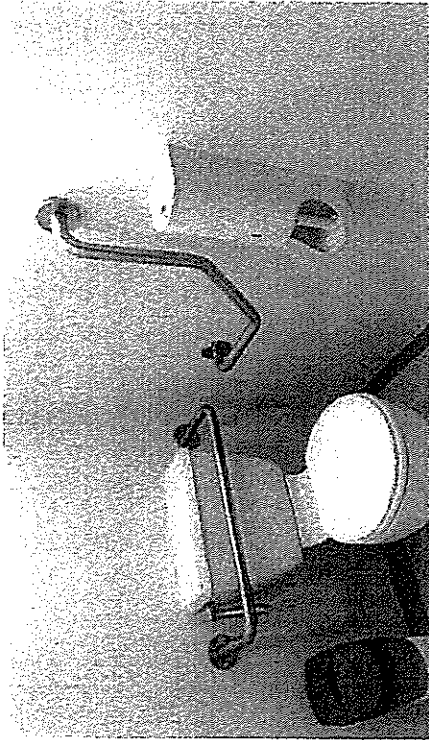

PARAPLEGIC TOILET:
Fully fitted Disabled toilet with all requirements

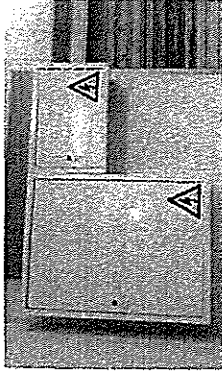

DISTRIBUTION BOX:
Fully Independent DB Box for SASSA
All switches independently labelled
Lockable and intruder proof

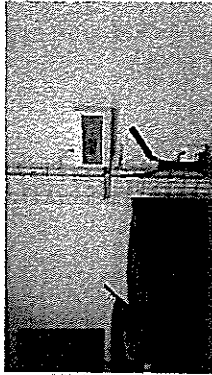

DB BOX - SERVER ROOM:
Independent DB for Server room with Air-condition unit

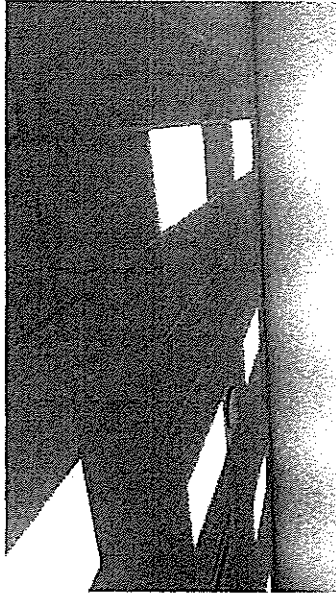

SUSPENDED DROP CEILING:
Quality ceilings with LED light-fittings
Extractor fans
Air condition units placed to distribute fresh air evenly

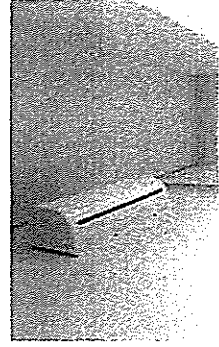

WALL HUNG A/C:
Fixed to solid walls

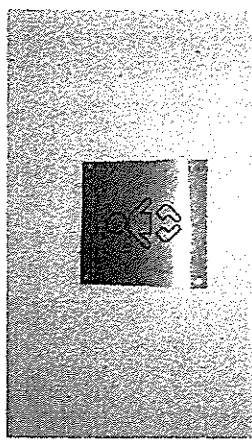

BABY CHANGING:
Fully fitted with basin, table and Mirror

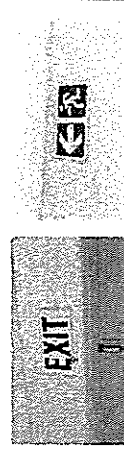

GENERAL SIGNAGE:
Functional OHS signage

DRAWING PROVIDED BY:
Mr Robert Henricks
Cell: 072 17 668 37

PROJECT DESCRIPTION:
NEW SASSA PAARL LOCAL OFFICE PROJECT
20 MAY 2019

PROJECT ADDRESS:
BROADWAY STREET
PAARL EAST

SHEET TITLE:

NO.	REVISIONS	BY	DATE

SCALE:

DATE: 2019-10-07



sassa



sassa

SOUTH AFRICAN SOCIAL SECURITY AGENCY

CORPORATE BRANDING:

Guidelines on the application of the SASSA corporate identity

[*paying the right social grant, to the right person,
at the right time and place. NJALO!*

Our Vision, mission and values

Vision

A comprehensive social security service that assists people in being self-sufficient and supporting those in need

Mission

To manage quality social security services to eligible and potential beneficiaries effectively and efficiently

Values

The Agency, as a public entity, subscribes to values that promote democracy and a culture of respect for human rights.

- Social Cohesion
- Confidentiality
- Integrity
- Fairness
- Transparency
- Equity
- Customer Care-Centred Approach

Introduction

Communication through signage creates a huge opportunity to build the SASSA brand. "Signage helps people identify, navigate, and understand environments". - Allan Jacobson

Objectives

- Increase expression of the SASSA Brand
- Ensure easy identification, information and advertising of the SASSA Brand
- Create a uniform way of expressing the SASSA brand "spirit" across all its offices

Signage considerations

- Signage must complement existing SASSA building Architecture and based on Interior Guidelines (whether interior or exterior)
- There should be maintenance plans linked with installation of signage over the long-term or post installation
- In certain municipal areas, there are zoning rules that apply. This must be noted and adhered to.
- Exterior signage must take into account pedestrians and vehicles passing the building
- Ensure high visibility, positioning, legibility and durability for impact

Our Name

In all respects, the organisation shall be known as the "South African Social Security Agency" and abbreviated "SASSA". This naming approach will help entrench the SASSA brand name and is critical marketing the organisation. Any abbreviated reference to the organisation will be "SASSA" (in caps) and not, for example, "the Agency". This name shall be at the front and back of every publication the organisation produces.

Why should SASSA strive for uniformity in environmental signage?

The aim of uniformity is to consistently promote a certain look and feel as the correct identity and apply this consistently to a point that it resonates with SASSA clients wherever the organisation is represented.

Our visual identity

Secondary logos apply only when it is difficult to make use of the primary logo, for example, for signage. All environmental signage for SASSA should use the horizontal logo and vertical versions of the logo.

SASSA payoff line/tagline

The pay off line is unjustified and normally a double deck. Single Colour applications/Two Colour options. In cases where a full colour logo cannot be used, single/two color logo provide a viable options. Please note that this options is mainly in primary colours.

Why should SASSA strive for uniformity in environmental signage?

The aim of uniformity is to consistently promote a certain look and feel as the correct identity and apply this consistently to a point that it resonates with SASSA clients wherever the organisation is represented.

Our visual identity

Secondary logos apply only when it is difficult to make use of the primary logo, for example, for signage. All environmental signage for SASSA should use the horizontal logo and vertical versions of the logo.

SASSA payoff line/tagline

The pay off line is unjustified and normally a double deck. Single Colour applications/Two Colour options. In cases where a full colour logo cannot be used, single/two color logo provide a viable options. Please note that this options is mainly in primary colours.

Prominence of SASSA corporate identity

All designs and displays at SASSA offices should prominently display its identity. All messaging should be approved by the Marketing and Communication Unit to ensure consistent application and compliance with set corporate identity standard and brand strategy.

Brand endorsements

SASSA may not endorse a particular product or services at the expense of its identity, for example, displaying vendor machines in key SASSA areas.

Other elements of the SASSA Visual Identity

The SASSA curve

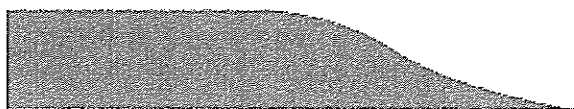

The SASSA curve is a vital element of the visual identity and style for all SASSA products. This can be applied both in primary and secondary colours.

The SASSA left bracket and official font

The SASSA bracket [, which is normally placed on the left of a sentence/word/ design is also an important element of the SASSA house style. This should be used as prominently as possible. The official font (Body Text) for all SASSA documents is Arial.

The SASSA hands symbol



The SASSA hands "symbol" contain hands in a radial format. This can be utilised in restricted areas as watermarks. Hands should be utilised in various formats to compliment other visual design elements of the SASSA signature.

SASSA payoff line/tag line

*[paying the right social grant, to the right person,
at the right time and place. NJALO!]*

The pay off line is unjustified and normally a double deck. The tagline is originally in Granjon Italic OSF font. In cases where this font is available, Arial - SASSA's official font - should be used.

The SASSA Colour Palette (primary colours)

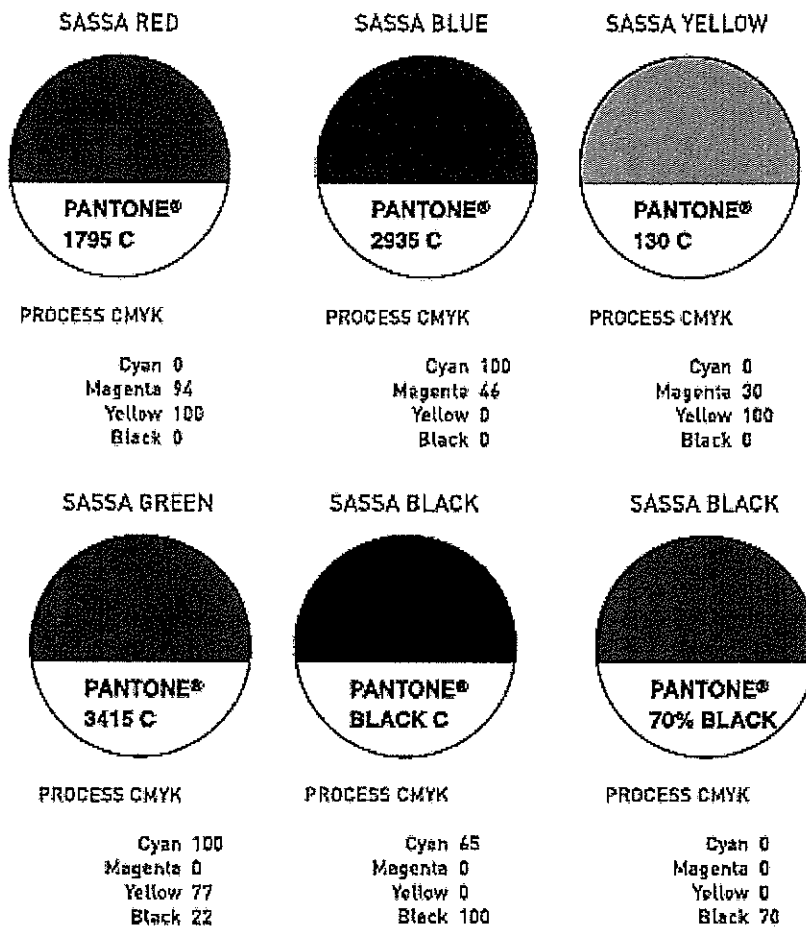

The SASSA Primary Colour Palette is derived from our logo and should be used as specified above. It is the primary reproduction colour palette. Convert CMYK to RGB when required but align to pantone palette for consistency. Exact swatches should be utilised for exact colour matching SASSA promotional items, publications, etc

The SASSA Colour Palette (secondary/complementary colours)

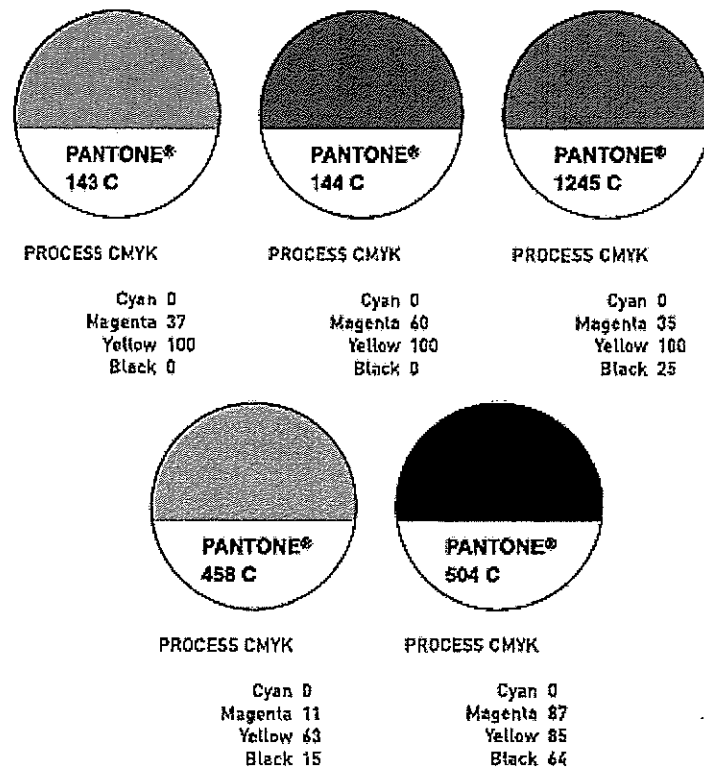

The SASSA Secondary Colour Palette uses earthy tones that complement our primary colour palette. The secondary colour palette/colours are restricted colours. These should be used as backgrounds and to add flavour and "freshness" to the SASSA work environment. The palette are also reserved for exterior and interior of SASSA buildings. The palette conveys a warm, caring, professional and approachable atmosphere in the SASSA office environment. Pantone 458C is used for all wall coatings, interior and exterior, completed by a dynamic Pantone 144C, Pantone 143 C or Pantone 504C.

Use of Secondary Colours (restricted)

The secondary colour palette/colours are restricted colours. These should be used as backgrounds and to add flavour and "freshness" to designs/ artwork/ environment. These are also reserved for exterior and interior of SASSA buildings. Exact swatches should be utilised for exact colour matching SASSA promotional items, publications, etc.

SASSA Yellow & primary colour

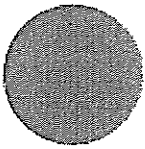

This is the prominent colour of SASSA, for all designs, for example, as a curve on walls/signage

SASSA Orange

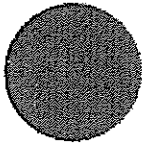

This colour should be used to highlight or emphasis

SASSA Browns and Maroons

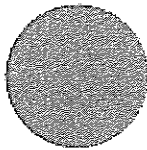
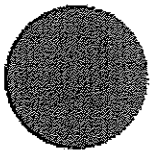

These colours should be used as backgrounds or highlighters, for example, for walls, ceilings and carpets and tiles

Complementary/neutral colours

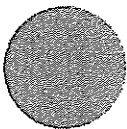

Pantone 458 C **SASSA Grey**

C: 0
M: 11
Y: 63
K: 15

C: 0
M: 0
Y: 0
K: 70

The SASSA Yellow is the main (primary) colour for SASSA. This colour should be used as extensive as possible in all formats of products the organisation develops.

Office Interiors

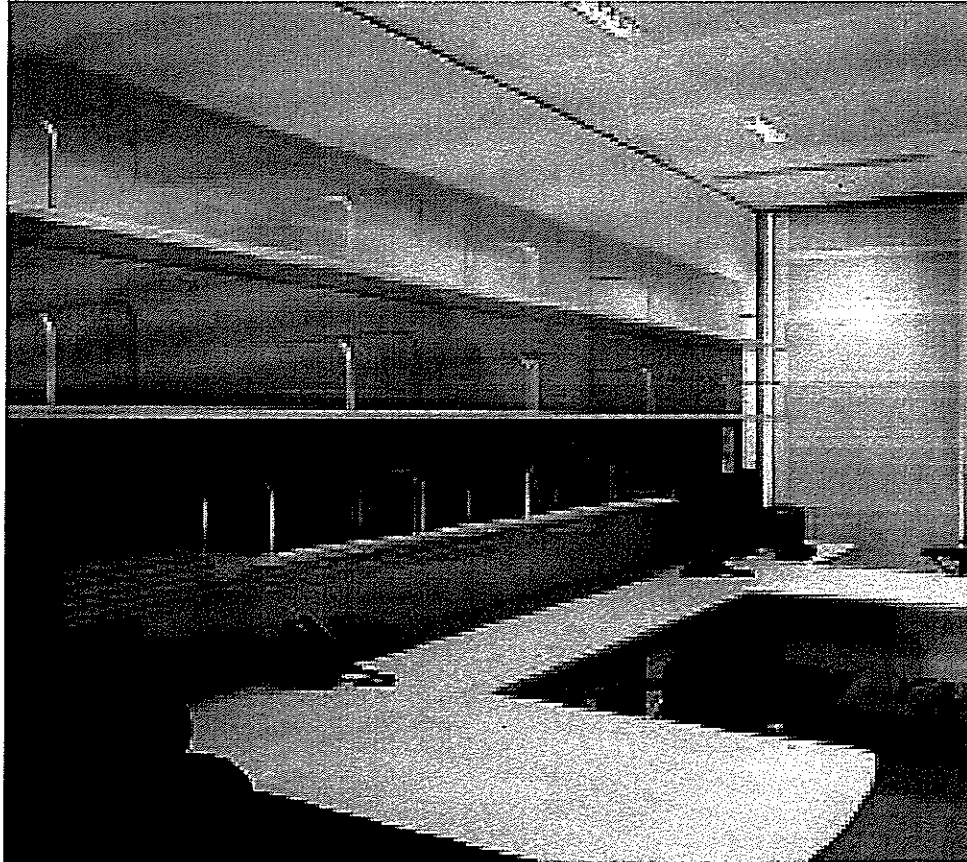

In portraying a professional image of SASSA, it is vital to create a work environment that exudes confidence and productivity. A warm and caring environment that consists of clean and simple lines is essential. The overall straw colour is Pantone 458C which allows for accessories to be in our vibrant primary palette thus tastefully lifting a look of feel environment. For furniture. Worktop surfaces are decorative laminate in Vancouver Maple 688, Underside finished with quality 0.33mm balancing backer, not paper.

Shop fronts

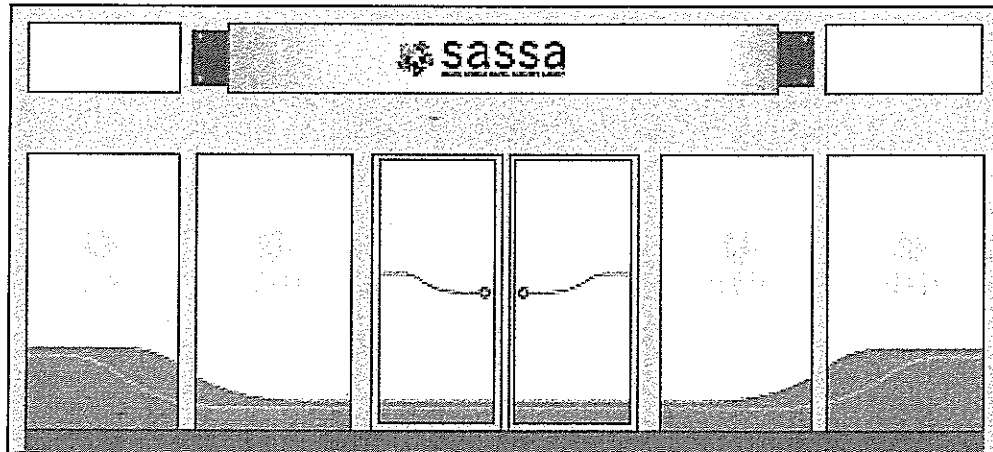

The shopfront illustrated is a typical example of application of elements of the SASSA corporate identity and serves as a guideline. Various factors must also be taken into account when applying signage, for example, visibility, size and traffic flow within the identified area. Thus, SASSA shopfronts should have: The SASSA identifier sign, the SASSA logo frosted on windows, and the SASSA curve in colour of frosted as indicated above.

Glass boardrooms/entrances

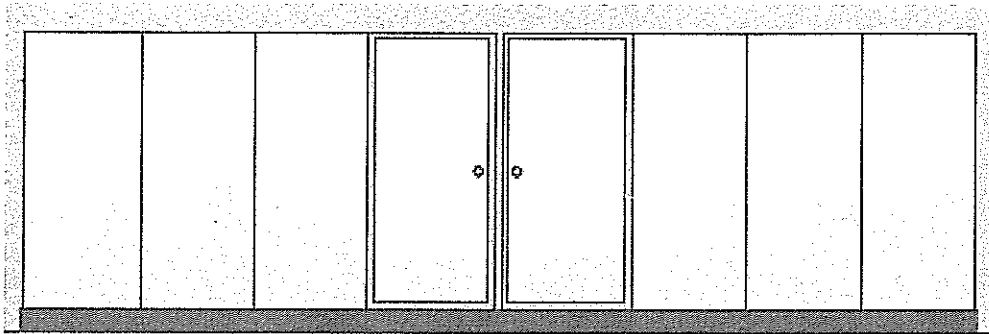

On the entrances of glass boardrooms the dynamic element of the SASSA corporate identity - the SASSA curve - is frosted and laminated on the glass. Furthermore, door and window frames should be aluminium/grey/silver. This includes door frames.

Window, door frames and other finishings



Window, door frames and skirtings should be grey aluminium/silver. Silver/grey blinds are also compulsory. The same applies to door handles. Prescribed door handles should be Antique Aluminium pull handle. Technical requirements are available from the Unit:Facilities Management.

Carpets

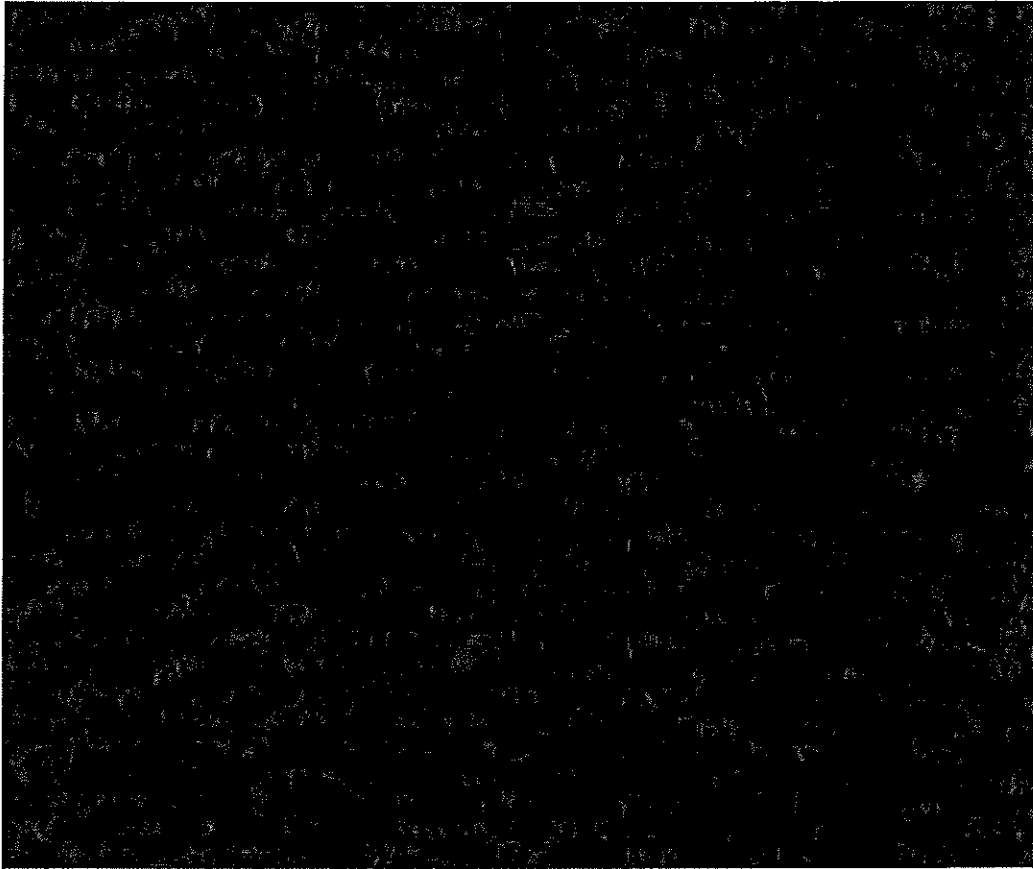

All SASSA offices must be carpeted with 600 x 600 x 6.6 mm Bilgotex Red Oxide Point 920 tiles. The colour of the carpet tiles has been chosen to obscure any dirt while at the same time being hardworking and durable. The carpet tiles are to be used in high volume areas, for example, receptions.

Wooden flooring

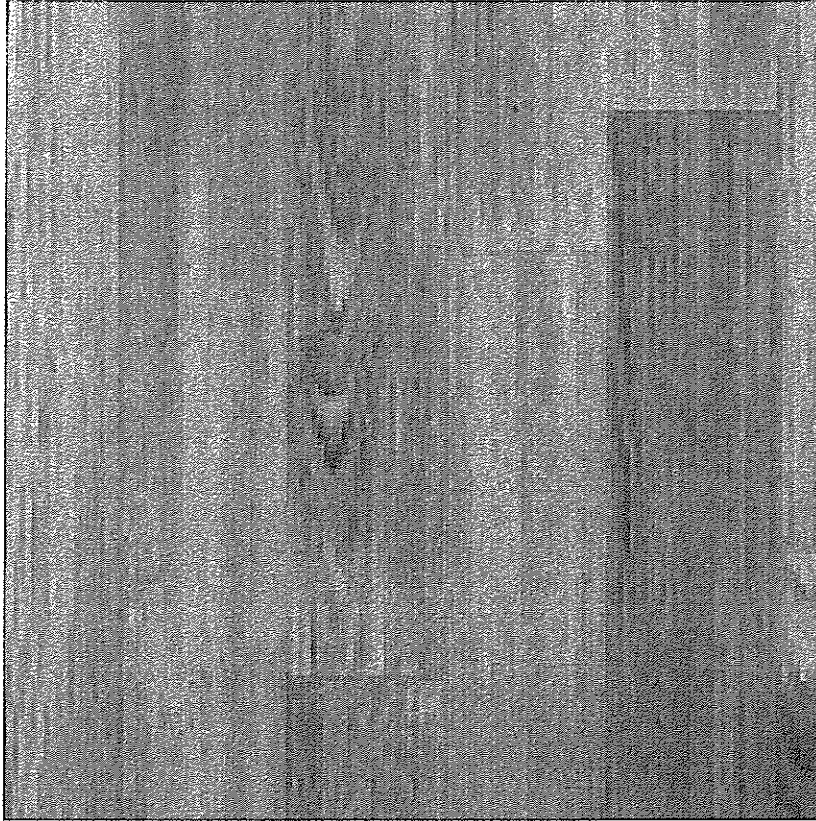

As with the SASSA furnisher, the wooden floor for SASSA offices is decorative laminate Vancouver Maple 688 and should be maintained to create a clean look. Wooden floors should be limited in short passages or pause areas. Wooden floor should not be used in workstations.

Floor tiles arrangement

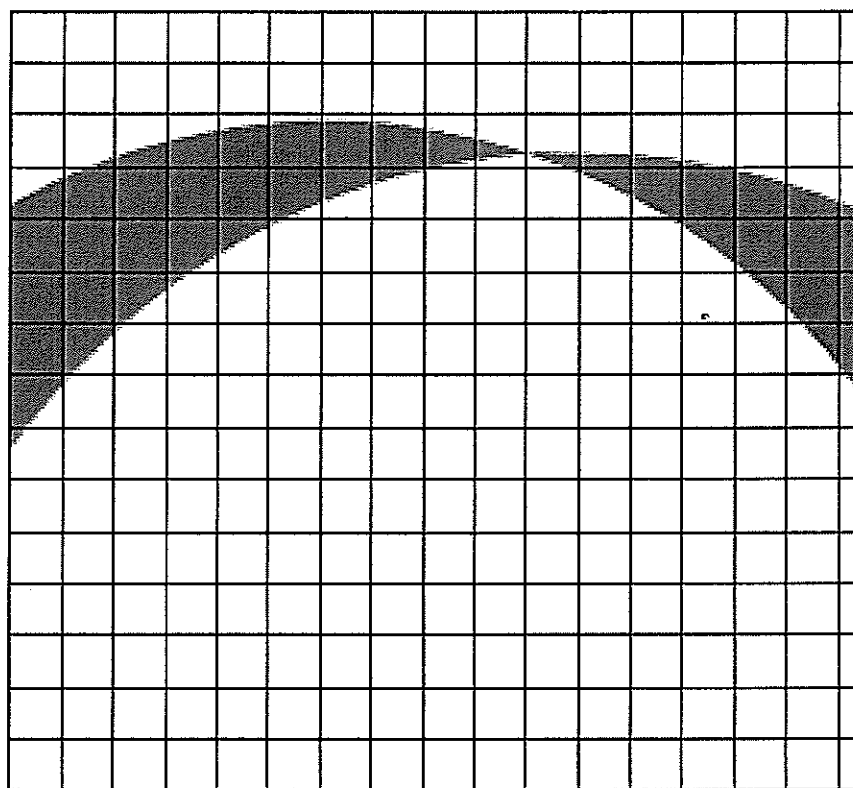

Ceramic tiles utilised for SASSA office floors is 300x300 x 2.5 MarleyFlex Beige (matching with Pantone 458C). This gives a dynamic and clean contemporary look for SASSA interiors, especially with a straight arrangement of tiles.

Toilet tiles



Ceramic tiles utilised for SASSA office floors is 300x300 x 2.5 MarleyFlex Beige (matching with Pantone 458C). This gives a dynamic and clean contemporary look for SASSA interiors, especially with a straight arrangement of tiles. A belt of Pantone 504C should be used above the Beige tiles as indicated above.

Skirtings



Skirting for SASSA is maple painted with high gloss enamel paint or aluminium. Timber skirting is visible to our customer, and has a very important role in creating overall ambience. Thus, the skirting has been designed in both maple, to match the SASSA furnishers and incorporates an aluminium runner to match the overall stainless steel looks. No skirtings should be used in toilets.

Ceilings

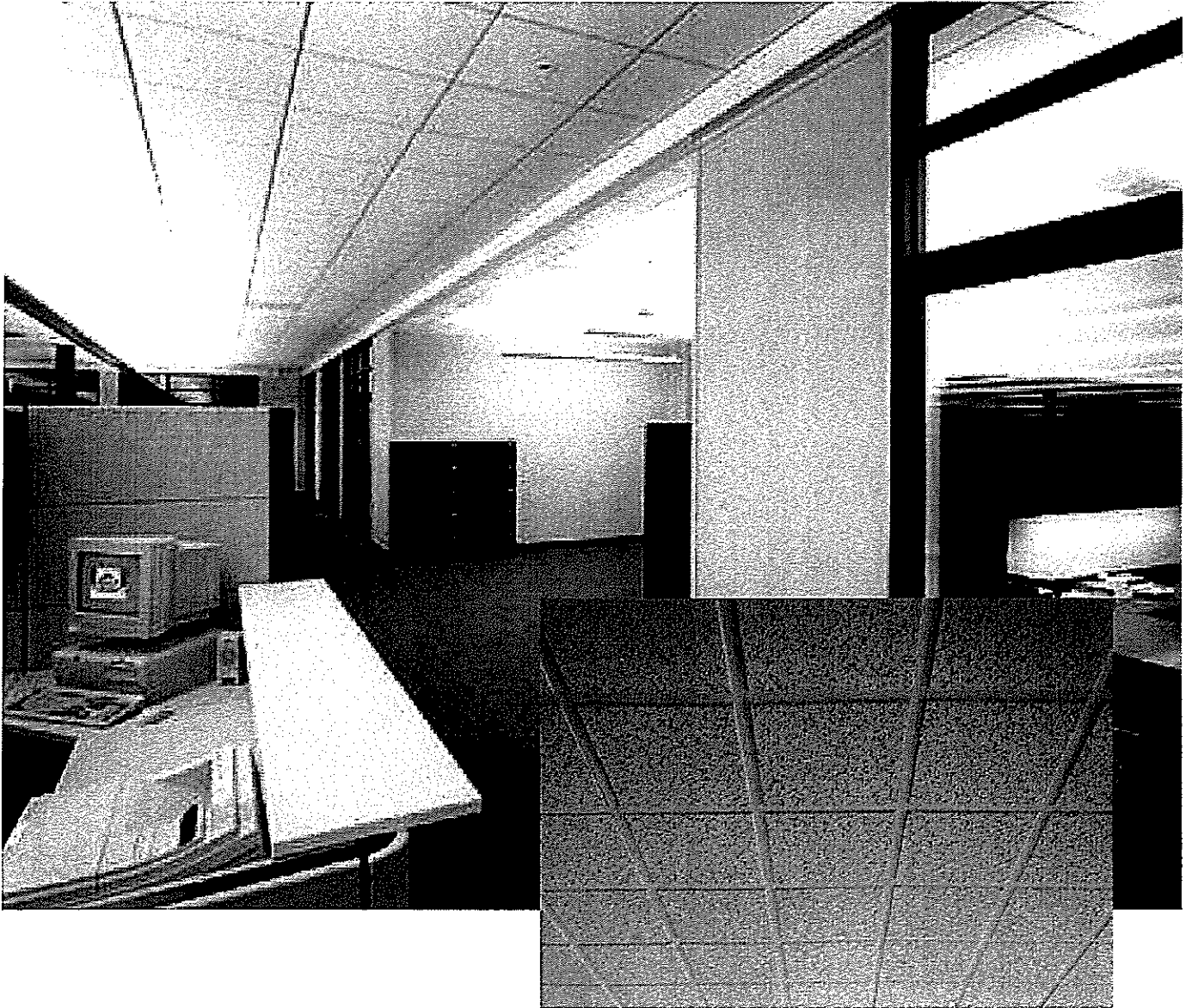

SASSA ceilings can either be plastered concrete or gypsum plastered-board or suspended ceilings. All plastered or board ceilings to be painted with white PVA paint.

Walls

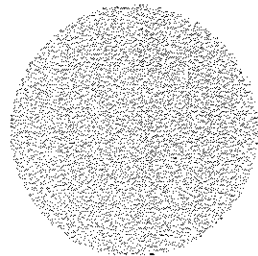

**Plascon
Rice Paper
VEL 45**

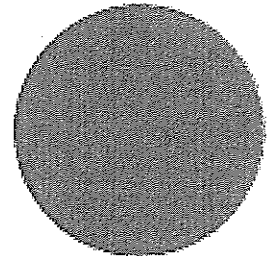

**Micatex
Kalahari
BBO 3110**

All interior walls are to be painted on Plascon Rice Paper VEL 45. All exterior walls are to be painted with Micatex Kalahari BBO 3110. These colours are within the SASSA Pantone 458C.

Lighting

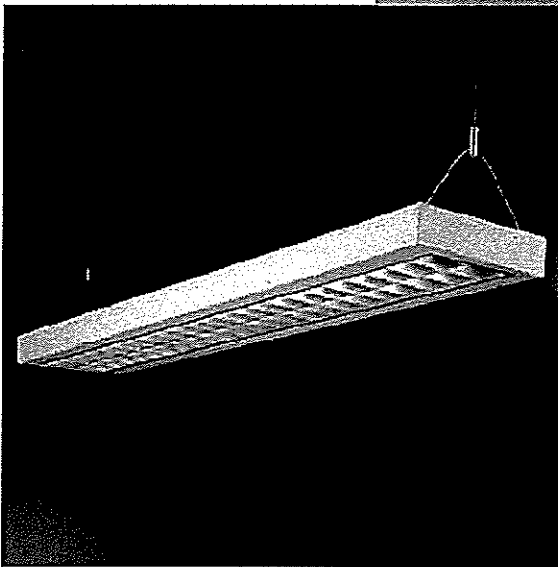
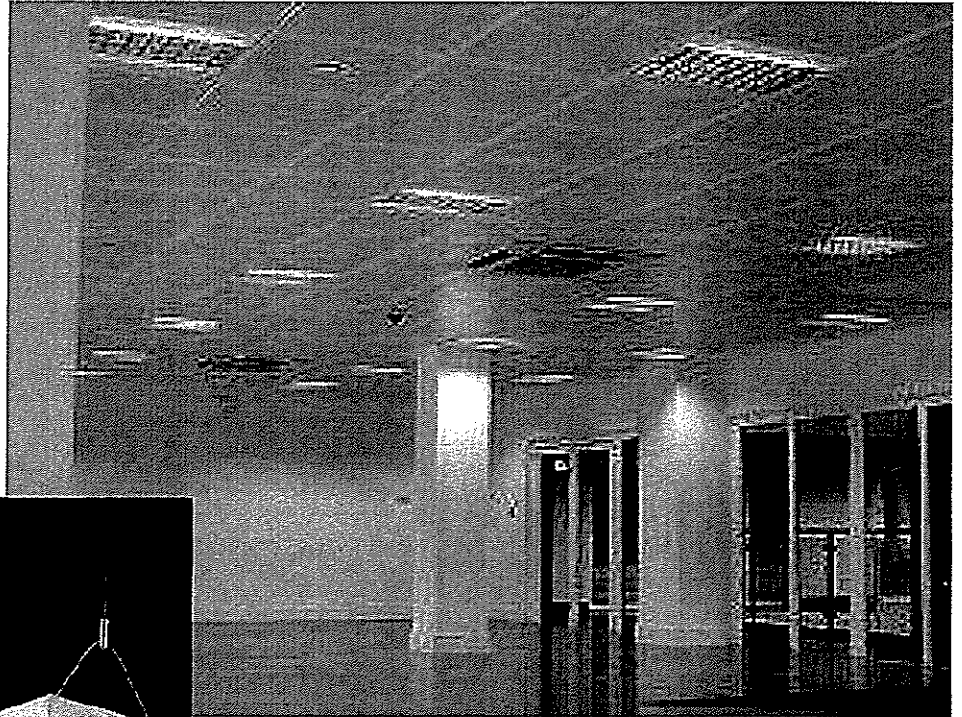

Lighting intensity to be a minimum 300 Lux on offices and 500 lux in public areas. To underside of ceiling fit 1200 flush recessed fluorescent light fitting with prismatic acrylic cover.

Reception & Waiting area seating



A steel bench should be used in all waiting areas due to its user-friendliness. For high volume areas, the three seater steel bench is easy to clean and look after and is a highly economical use of office space with great flexibility. This guide is also in line with the SASSA furnisher style and is simple to assemble and disassemble. Care must also be taken to ensure that broken steel benches are replaced and maintained.

SASSA reception areas

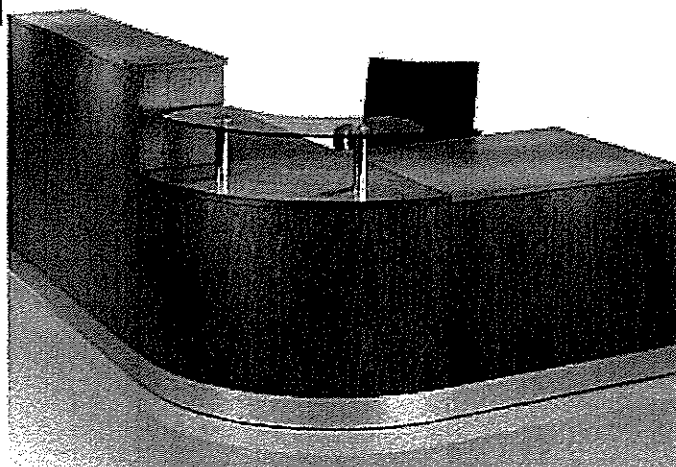
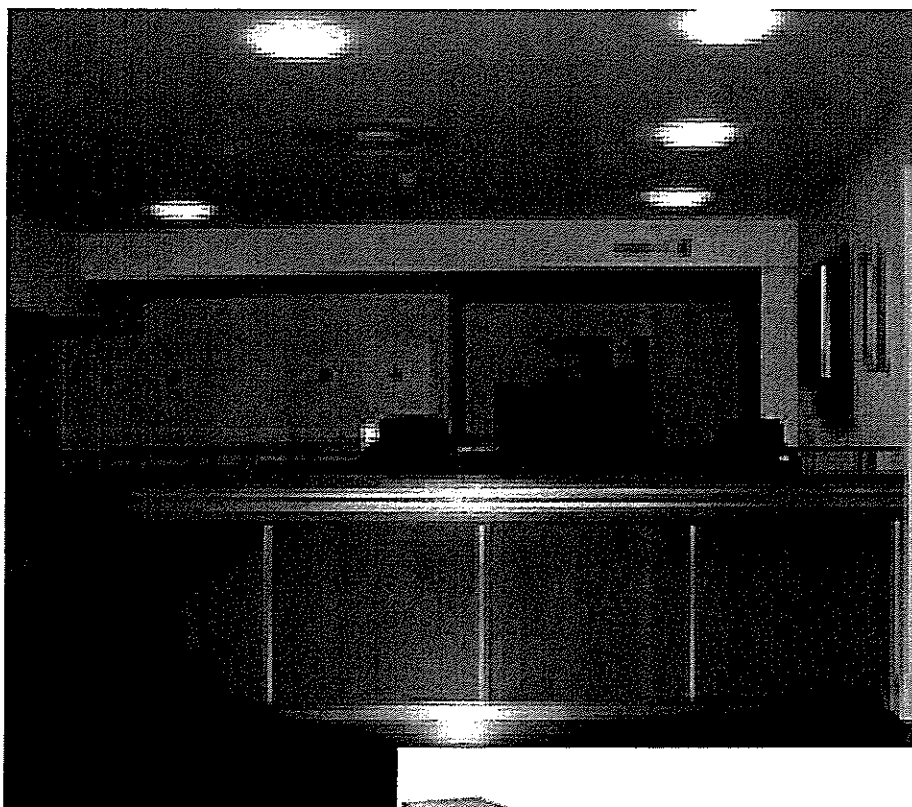

SASSA reception areas, should have: SASSA Vision, Mission and Values prominently displayed; Information Signage of various floors of the building; pictures of political principals. Reception desks should be "C-shaped, semi-circle or L-shaped as indicated above", and in decorative laminate Vancouver Maple 688.

SASSA reception couches

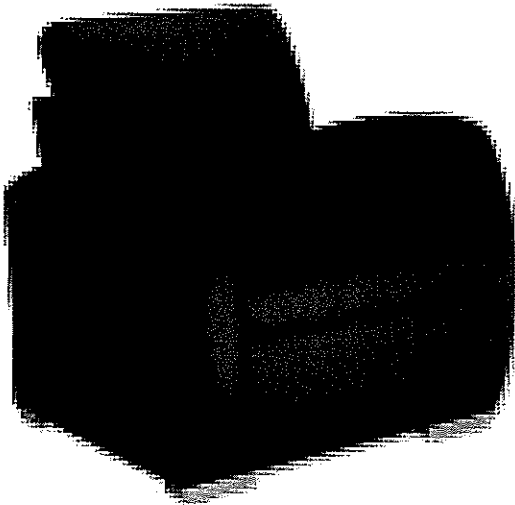

SASSA reception areas which use couches should use black or beige.

SASSA service cubicles

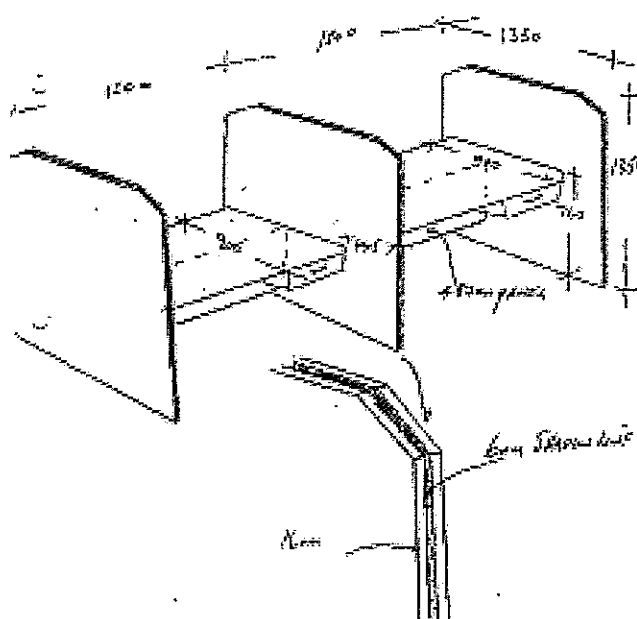

As a service oriented organisation, SASSA provides services where there is constant professional interaction with clients. For this purpose, service cubicles are vital. The cubicles construction, look and feel take cue from the SASSA furnisher with a consistent use of decorative laminated Vancouver Maple 688.

Workstation seating



A SASSA Workstation furnisher is a combination of the decorative laminate Vancouver Maple 688 furnisher desk and burnt orange chairs with wheels. The orange is one of the key highlighters within the SASSA corporate colours.

Cluster workstations

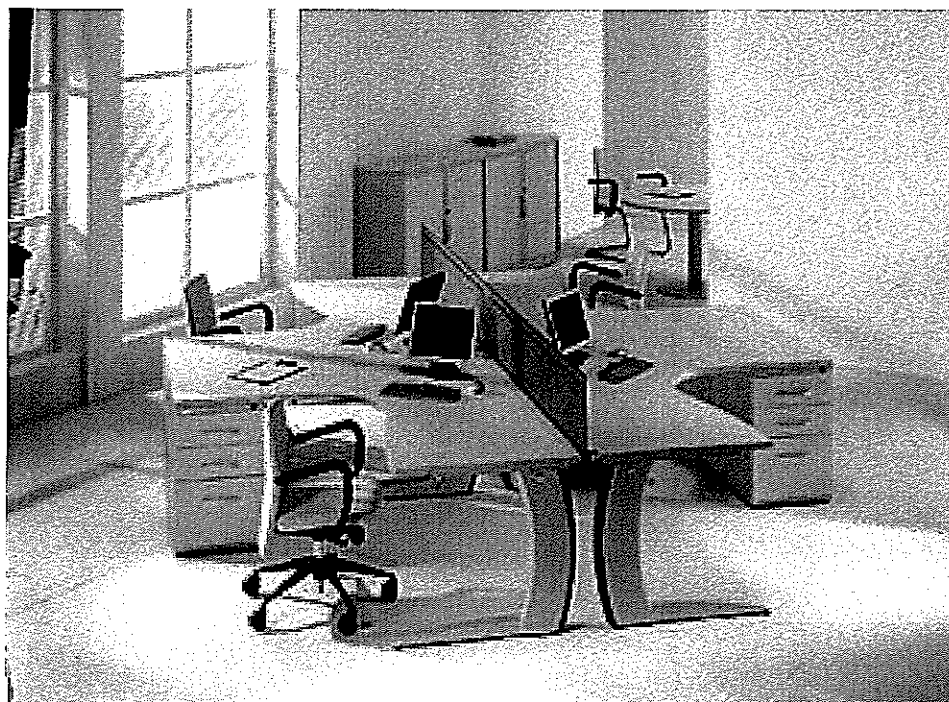

SASSA cluster workstation are decorative laminate Vancouver Maple 688 with silver finishing (where applicable) creates an uncluttered workstation environment

Office furnisher



The key feature of the SASSA furnisher is consistent use of decorative laminate Vancouver Maple 688 with quality silver finishings. This creates attractive business environment with a contemporary setting.

Boardroom Tables

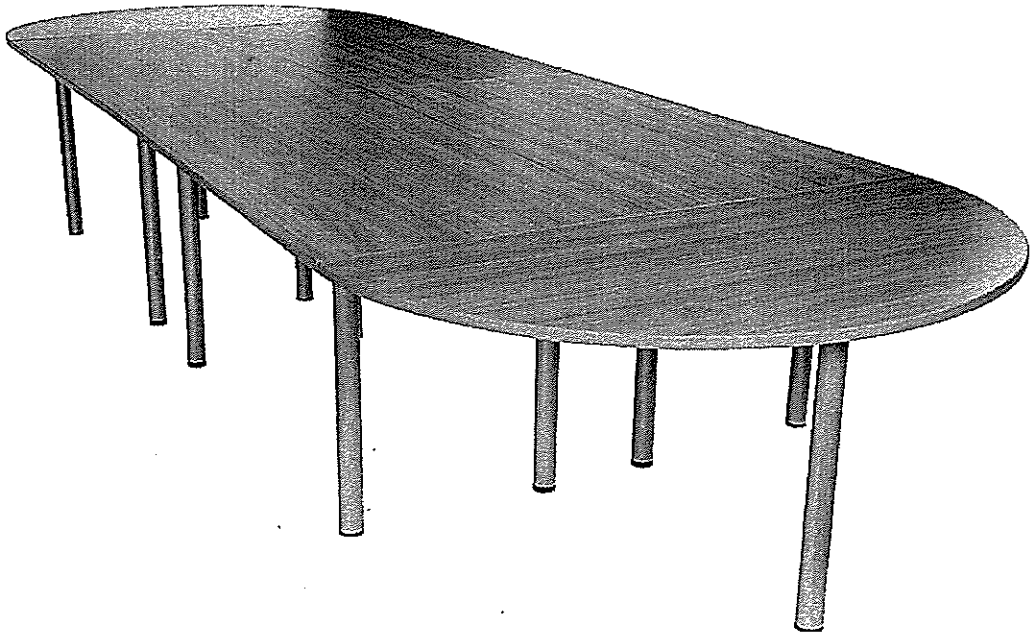

SASSA boardroom table are also decorative laminate Vancouver Maple 688 with silver finishing. In cases where the boardroom table has colour, this will be black. Boardroom chairs should also be black.

Pause area seating



Pause or resting areas will have coloured chairs with the decorative laminate Vancouver Maple 688 table with silver finishing as indicated. This will be based on the SASSA brand colours. Above all, bright pause areas offer opportunities to revitalise and provide energy through colour.

Environmental Signage approach for SASSA



All environmental signage for SASSA should use the horizontal logo (secondary logo) in FULL COLOUR. In cases where the horizontal logo cannot be used or is difficult to use it the SASSA primary logo shall be applied.

Waste Disposal

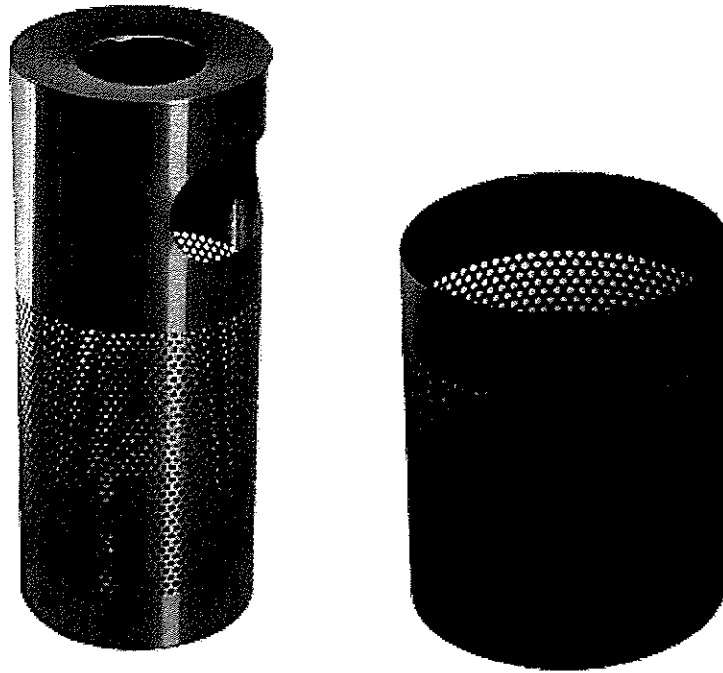

The waste paper bins are designed to be conveniently positioned for staff members & clients. They can either be silver/grey and black.

Environmental signage

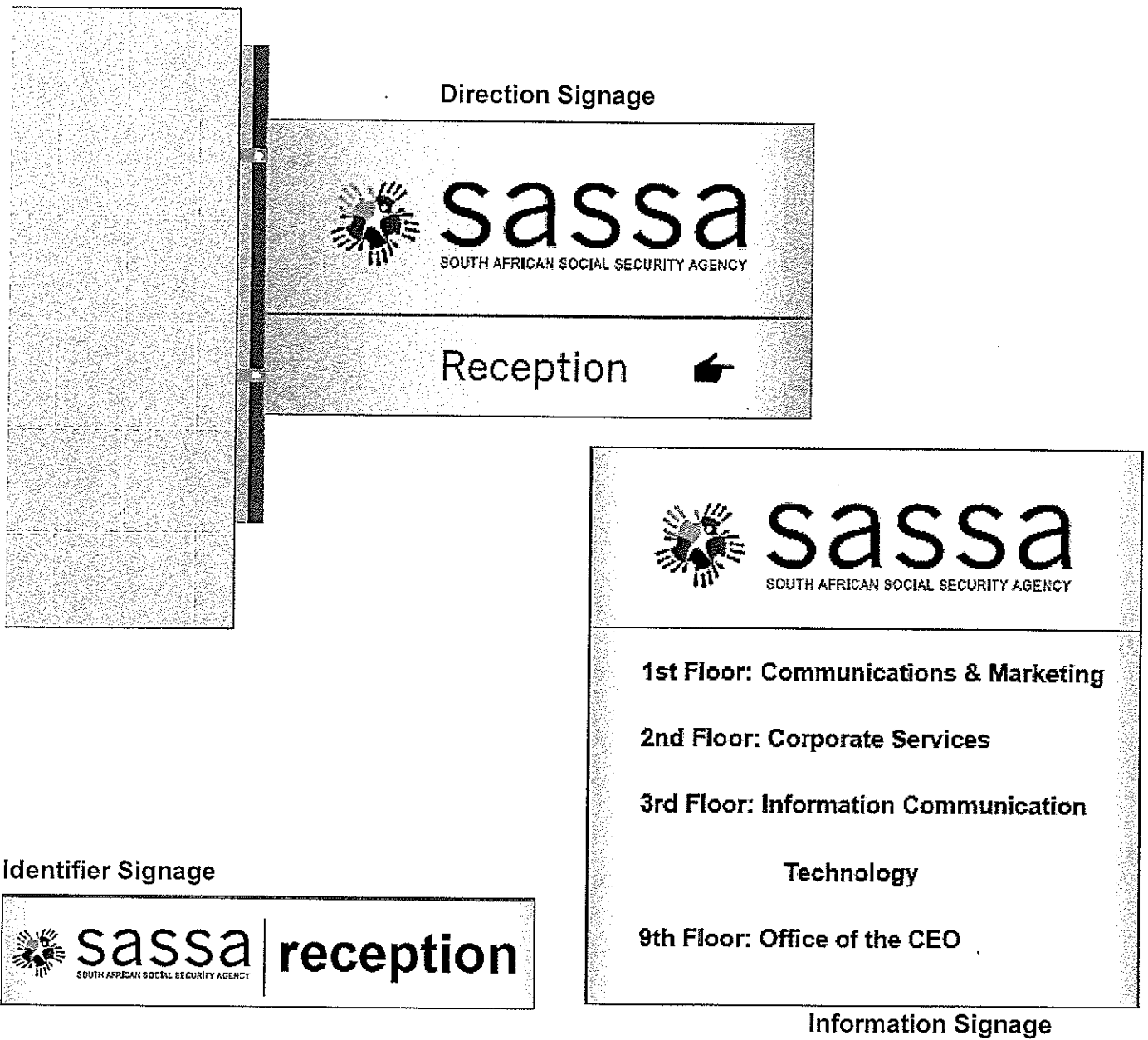

*All information of any sign (Identifier, directional or informational) should first be preceded by the SASSA logo on top. There should also be a space between the logo on top and the directions below it. Fonts should be black arial and be visible. Vista systems are recommended in silver or white. *The recommended signs for SASSA signage is Vista System**

Environmental Signage implementation - the process

- | | | | |
|----------|--|----------|---|
| 1 | Establish project goal
Determine project scope
Define and understand needs & habits
Clarify functions
Develop time frame & budget | 2 | Build project team
Liaise with facilities management
Develop information for design & specifications
Liaise with Senior Manager: Marketing & Publications |
| 3 | Conduct Research
Conduct Site Audit: Building type, local codes, zoning, traffic conditions
Compile Report | 4 | Establish project criteria
check: Visibility,
Positioning, Safety, Security
Maintenance, |
| 5 | Begin design schematic
brand identity collateral
Determine colour, scale, format
Typography
Mounting, and Placement | 6 | Develop design
Check envisaged v/s actual
Prepare prototypes
Finalise conten & actual specs
Create drawings or renderings & colour |
| 7 | Complete relevant documents
Finalise specifications
Submit for procurement process
Apply for permission, where necessary | 8 | Manage process
Manage and check installation
Inspect work in terms of requirements and specs |

Brand management for SASSA

The Marketing and Communication Units are responsible for maintenance of the SASSA corporate identity. Even so, budget might not necessarily reside in this unit, but when any brand management related activity is undertaken, the marketing and communication unit must form part of the project team and execution.

For more information about these guidelines contact:

For more information contact

Moabi Pitsi

(012) 400 2133

084 300 2242

moabip@sassa.gov.za

or

Regional Marketing and Communication Units