

BID / TENDER NO. CPTL14/23

Department:
Public Works and Infrastructure

REPUBLIC OF SOUTH AFRICA

public works
& infrastructure

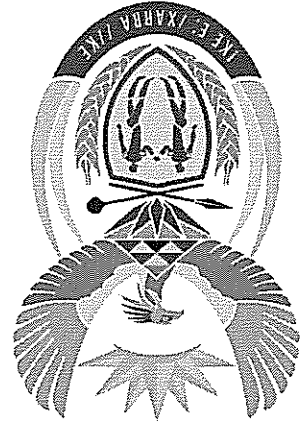

PA-04 (LS): NOTICE AND INVITATION TO BID

THE DEPARTMENT OF PUBLIC WORKS INVITES BIDDERS FOR PROVISION OF:

Property description: SASSA: VRENDENTAL LOCAL OFFICE: OPEN TENDER PROCEDURE TO PROCURE NEW OFFICE ACCOMMODATION FOR A PERIOD OF FIVE (5) YEARS: LETTABLE GUIDELINE: 593,75M ² AND 8 PARKING BAYS (UNDER COVER SECURED PARKING BAYS)
--

Bid no: CPTL14/23	Advertising date: 28 July 2023	Closing time: 11:00
Closing date: 18 August 2023	Validity period: 84 days	Closing date: 18 August 2023

1. FUNCTIONALITY CRITERIA APPLICABLE YES NO
- Note 1:** Failure to meet minimum functionality score will result in the tenderer being disqualified.

Functionality criteria ¹	Weighting factor:
Total	100 Points

(Weights will be multiplied by the scores allocated during the evaluation process to arrive at the total functionality points)

Minimum functionality score to qualify for further evaluation: N/A

((Total minimum qualifying score for functionality is 50 percent, any deviation below or above the 50 percent, provide motivation below.

--

¹ The points allocated to each functionality criterion should not be generic but should be determined separately for each tender on a case by case basis.

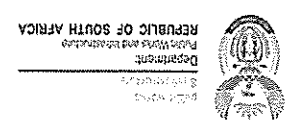

2. APPROVAL IS HEREBY REQUESTED FOR THE FOLLOWING PROCUREMENT PROCEDURE:

Method 1 (Financial offer) Method 2 (Financial and Preference offer)

2.1. Indicate which preference points scoring system is applicable for this bid:

<input checked="" type="checkbox"/> 80/20 Preference points scoring system	<input type="checkbox"/> 90/10 Preference points scoring system	<input type="checkbox"/> Either 80/20 or 90/10 Preference points scoring system
--	---	---

3. RESPONSIVENESS CRITERIA

3.1. Indicate substantive responsiveness criteria applicable for this tender. Failure to comply with the criteria stated hereunder shall result in the tender offer being disqualified from further consideration:

1	<input checked="" type="checkbox"/>	Only those tenders who satisfy the eligibility criteria stated in the Tender Data may submit tenders.
---	-------------------------------------	---

2	<input checked="" type="checkbox"/>	Tender offer must be properly received on the tender closing date and time specified on the invitation, fully completed either electronically (if issued in electronic format), or by writing legibly in non-erasable ink. (All as per Standard Conditions of Tender).
3	<input checked="" type="checkbox"/>	The offer should be submitted as per the bid questionnaire which forms part of the bid documents. of the financial offer in terms of rental and tenant installation allowance offered by the bidder. The (DPWI-08 (LS)): Bid offer must be clearly completed by the bidder, with clear specification
4	<input checked="" type="checkbox"/>	The building must be within the geographic boundaries specified in the bid documents.
5	<input checked="" type="checkbox"/>	Use of correction fluid is prohibited.

6	<input checked="" type="checkbox"/>	Submission of record of attending compulsory virtual bid clarification / site inspection meeting. Clarification of the bid document. During the meeting the bidder and DPW representative must sign the DPW-16 (EC) form as the record of attendance.
7	<input checked="" type="checkbox"/>	An agent may bid on behalf of the owner of the Property but the responsiveness of the bid only measured on the owner/real owner of the property. No points will be given to the Agent unless he/she is buying a property. A copy of the mandate from the owner must be submitted with the bid documents or in case of prospective buyer the signed purchased agreement with a Title deed of the owner must be submitted. Title deed will be required if the tenderer owns the building

8	<input checked="" type="checkbox"/>	The bidder must attach a locality map, e.g., a Google printout. The Department reserves the right to verify the submitted maps. See Annexure A, page 1, paragraph 2.1 of the Special Conditions of the Bid.
9	<input checked="" type="checkbox"/>	The bidder must provide proof of the space required in the form of drawings / floor plans. See Annexure A, page 1, paragraph 2.2 of the Special Conditions of the Bid.
10	<input checked="" type="checkbox"/>	The bidder must submit an approved Town Planning Certificate or Zoning certificate from the Local Municipality confirming the appropriate land use for the requested land. See Annexure A, page 2, paragraph 2.3, of the Special Conditions and the Bid.

3.2. Indicate administrative requirements applicable for this tender. Tenders may be required to submit the below documents where applicable.

The Employer reserves the right to request further information regarding the undermentioned criteria. Failing to submit further clarification and/or documentation within seven (7) calendar days from request or as specifically indicated, will disqualify the tender offer from further consideration.

1	<input checked="" type="checkbox"/>	Any correction to be initiated by the person authorised to sign the tender documentation as per PA 15.1 or PA 15.2 resolution of boards/ of directors / or PA15.3 Special Resolution of Consortia or JVs.
2	<input checked="" type="checkbox"/>	Submission of applicable (PA-15.1, PA-15.2, PA-15.3): Resolution by the legal entity, or consortium / joint venture, authorising a dedicated person(s) to sign documents on behalf of the firm / consortium / joint venture.



3	Submission of (PA-11): Bidder's disclosure.	<input checked="" type="checkbox"/>
4	Submission of (PA 40): Declaration of Designated Groups for Preferential Procurement.	<input checked="" type="checkbox"/>
5	Submission of proof of Registration on National Treasury's Central Supplier Database (CSD).	<input checked="" type="checkbox"/>
6	Specify other responsiveness criteria	<input type="checkbox"/>
7	Specify other responsiveness criteria	<input type="checkbox"/>
8	Specify other responsiveness criteria	<input type="checkbox"/>

3.3. Indicate administrative requirements applicable for specific goals, Tenderers will not be required to submit the below document if not provided in the original tender proposal, Failure to comply with the criteria stated hereunder shall result in the tenderer not allocated points for specific goals.

1	Submission of (PA-16): Preference Points Claim Form in terms of the Preferential Procurement Regulations 2022	<input checked="" type="checkbox"/>
2	A trust, consortium or joint venture (including unincorporated consortia and joint ventures) must submit a consolidated B-BBEE Certificate issued by a SANAS accredited service provider	<input checked="" type="checkbox"/>

4. COMPLIANCE WITH OBJECTIVE CRITERIA FOR PREFERENTIAL PROCUREMENT
(Applicable to Leasing Services only)

<input checked="" type="checkbox"/> Category A	Refers to segment where a property is owned by an enterprise(s) or individual(s) which are not less than. 51% Black ownership 51% Black managed 51% Black controlled and Enterprises in this category, depending on the requirements of the User Department qualify for leases of greater than 5 years.
<input checked="" type="checkbox"/> Category B	Refers to segment where a property is owned by an enterprise(s) or individual(s) which have not less than. 20% Black ownership 20% Black managed 20% Black controlled and Enterprises in this category, qualify for leases of a maximum 5 years.
<input type="checkbox"/> Category C	Refers to segment where a property is owned by an enterprise(s) or individual(s) with less than. 20% Black ownership 20% Black managed 20% Black controlled and Enterprises in this category, qualify for leases of a maximum 3 years.
<input checked="" type="checkbox"/> Category D	Refers to property funds listed on the stock exchange a) That qualify as listed property funds or Real Estate Investment Trusts (REITs) b) That have ownership by black individuals or black entities of more than 10% but less than 51% and c) That are managed by property asset management entities with not less than 51% Black ownership, 51% Black Management and 51% Black control. Enterprises in this category, qualify for leases of a maximum 5 years.

Table 1



5. METHOD TO BE USED TO CALCULATE POINTS FOR SPECIFIC GOALS



5.1. For procurement transaction with rand value greater than R1 Million and up to R50 Million (Inclusive of all applicable taxes) the specific goals listed in table 2 below are applicable.

Table 2

Serial No	Specific Goals	Preference Points Allocated out of 20	Documentation to be submitted by bidders to validate their claim
1.	An EME or QSE or any entity which is at least 51% owned by black people (Mandatory)	10	<ul style="list-style-type: none"> SANAS Accredited BBBEE Certificate or Sworn Affidavit where applicable.
2.	Located in a specific Local Municipality or District Municipality or Metro or Province area for work to be done or services to be rendered in that area (Mandatory)	2	<ul style="list-style-type: none"> Official Municipal Rates Statement which is in the name of the bidder. Or Any account or statement which is in the name of the bidder. Or Permission to Occupy from local chief in case of rural areas (PTO) which is in the name of the bidder. Or Lease Agreement which is in the name of the bidder.
3.	An EME or QSE or any entity which is at least 51% owned by black women (Mandatory)	4	<ul style="list-style-type: none"> SANAS Accredited BBBEE Certificate or Sworn Affidavit where applicable.
4.	An EME or QSE or any entity which is at least 51% owned by black people with disability (Mandatory)	2	<ul style="list-style-type: none"> SANAS Accredited BBBEE Certificate or Sworn Affidavit where applicable. and Medical Certificate indicating that the disability is permanent. Or South African Social Security Agency (SASSA) Registration indicating that the disability is permanent. Or National Council for Persons with Physical Disability in South Africa



5.	An EME or QSE or any entity which is at least 51% owned by black youth (Mandatory)	2	• ID and SANAS Accredited BBBEE Certificate or Sworn Affidavit where applicable.
----	--	---	--

5.2. For procurement transaction with rand value greater than R50 Million (inclusive of all applicable taxes) the specific goals listed in table 3 below are applicable.

NB. The use of one of goal numbers' 4 or 5 is mandatory. The BSC must select either one of the two, but not both.

Table 3

Serial No	Specific Goals	Preference Points Allocated out of 10	Documentation to be submitted by bidders to validate their claim
1.	An EME or QSE or any entity which is at least 51% owned by black people (Mandatory)	4	• SANAS Accredited BBBEE Certificate or Sworn Affidavit where applicable.
2.	Located in a specific Local Municipality or District or Metro or Province area for work to be done or services to be rendered in that area (Mandatory)	2	• Official Municipal Rates Statement which is in the name of the bidder. Or • Any account or statement which is in the name of the bidder. Or • Permission to Occupy from local chief in case of rural areas (PTO) which is in the name of the bidder. Or • Lease Agreement which is in the name of the bidder.
3.	An EME or QSE or any entity which is at least 51% owned by black women (mandatory)	2	• SANAS Accredited BBBEE Certificate or Sworn Affidavit where applicable.
4. <input type="checkbox"/>	An EME or QSE or any entity which is at least 51% owned by black people with disability (Mandatory)	2	• SANAS Accredited BBBEE Certificate or Sworn Affidavit where applicable. and • Medical Certificate indicating that the disability is permanent. Or • South African Social Security Agency (SASSA) Registration indicating that the disability is permanent. Or National Council for Persons with Physical Disability in South Africa registration (NCPDPSA).



	5. <input type="checkbox"/>	An EME or QSE or any entity which is at least 51% owned by black youth (Mandatory)	2	<ul style="list-style-type: none"> ID Copy and SANAS Accredited BBBEE Certificate or Sworn Affidavit where applicable
--	-----------------------------	--	---	---

6. COLLECTION OF BID DOCUMENTS:

Bid documents may be collected during working hours at the following address **Room 941 Customs House Building, Lower Heerengracht Street, Foreshore, Cape Town.**

A non-refundable bid deposit of **R200** is payable, (Cash only) is required on collection of the bid documents.

A compulsory pre bid meeting with representatives of the Department of Public Works will take place at **Customs House Building, Lower Heerengracht Street, Foreshore, Cape Town on 08 August 2023** starting at **11:00 Venue 11th Floor Main Boardroom. (if applicable)**

7. ENQUIRIES

7.1. Technical enquiries may be addressed to:

DPWI Project Manager		Andiswa Fitolli	Telephone no:	021 402 2326
Cellular phone no		0665143781	Fax no:	N/A
E-mail		Andiswa.fitolli@dpw.gov.za		

7.2. SCM enquiries may be addressed to:

SCM Official		Zodwa Tshoba	Telephone no:	021 402 2345
Cellular phone no		N/A	Fax no:	
E-mail		Zodwa.tshoba@dpw.gov.za		

8. DEPOSIT / RETURN OF BID DOCUMENTS:

8.1. Telegraphic, telephonic, telex, facsimile, electronic and / or late tenders will not be accepted.

8.2. Requirements for sealing, addressing, delivery, opening and assessment of tenders are stated in the bid document.

8.3. All tenders must be submitted on the official forms – (not to be re-typed).

<p> DEPOSITED IN THE TENDER BOX AT: MAIN ENTRANCE, GROUND FLOOR CUSTOMS HOUSE BUILDING LOWER HEERENGRACHT STREET FORESHORE, CAPE TOWN </p>	<p>OR</p>	<p> BID DOCUMENTS MAY BE POSTED TO: THE DIRECTOR -GENERAL DEPARTMENT OF PUBLIC WORKS PRIVATE BAG X 9027 CAPE TOWN 8000 ATTENTION: PROCUREMENT SECTION: ROOM 941 POSTED TENDERS MUST BE RECEIVED PRIOR CLOSING DATE AND TIME AT 11H00 BY THE DEPARTMENT </p>
---	-----------	--

DPW-16 (EC): SITE INSPECTION MEETING CERTIFICATE

Project title: SASSA: VRENDAL LOCAL OFFICE: OPEN TENDER PROCEDURE TO PRODUCE NEW OFFICE ACCOMMODATION FOR A PERIOD OF FIVE (5) YEARS: LETTABLE GUIDELINE: 593,75M ² AND 8 PARKING BAYS (UNDER COVER SECURED PARKING BAYS)	Tender / Quotation no: CPTL14/23	Closing date: 18 August 2023
Reference no:		

This is to certify that I, _____ representing _____

_____ in the capacity of _____

_____ visited the site on: **8 August 2023**

I have made myself familiar with all local conditions likely to influence the work and the cost thereof. I further certify that I am satisfied with the description of the work and explanations given at the site inspection meeting and that I understand perfectly the work to be done, as specified and implied, in the execution of this contract.

	Signature	Name of Tenderer
Date		

	Signature	Name of DPW Representative
Date		

SERIAL NO	DESCRIPTION OF ROOM	RANK/ LEVEL	PROPOSED PU	NORM PER PU	ASM	REMARKS
	ASSIGNABLE AREA					
	VREDENDAL					
	MANAGEMENT					
1	MANAGER					
2	ASSISTANT MANAGER	11-12	1	16.00	16.00	
			10	12.00	12.00	
	ADMINISTRATION					
3	AO/ STATE ACCOUNT TEAM LEADER					
4	AC/ SAC	8	3	8.00	24.00	
5	RECEPTIONIST	5-7	25	8.00	200.00	
6	GENERAL STORE		1	12.00	12.00	
7	CABINETS		1	12.00	12.00	
8	STATIONERY STORE		25	0.90	22.50	
9	TEA KITCHEN		1	12.00	12.00	
10	CONFERENCE ROOM		1	8.00	8.00	
11	PHOTOCOPY ROOM		1	50.00	50.00	
	PUBLIC SERVICE AREA		1	10.00	10.00	
12	WAITING AREA					
13	COUNTER		2	50.00	100.00	
14	AREA INFRONT OF COUNTER		4	1.50	6.00	
15	AREA BEHIND COUNTER		4	4.50	18.00	
16	OFFICE BEHIND COUNTER		4	2.00	8.00	
			1	12.00	12.00	
	NON ASSIGNABLE AREA (20%)				522.50	
	CIRCULATION, MAINTENANCE, DUTY AND STRUCTURAL SPACE				130.63	
	PARKING					
17	UNDER COVER PARKING		8			
	ABLUTION FACILITIES					

WESTERN CAPE: SASSA: VRENDENDAL LOCAL OFFICE GENERAL OF LEASE ACCOMMODATION

SERIAL NO	DESCRIPTION OF ROOM	RANK/ LEVEL	PROPOSED PU	NORM PER PU	ASM	REMARKS
18	MALE		2			
19	FEMALE		1			
20	FEMALE RESTROOMS		1			
TOTAL GUIDELINE GROSS AREA					553,73	
TOTAL LETTABLE AREA FOR LEASE PURPOSES					593,75	

COMPILED BY: [Signature]

DATE: 2015/09/28

CHECKED BY: [Signature]

DATE: 2015-09-29

CONFIRMED: ACCOMMODATION PARTICULARS AND SPACE NORMS APPLIED

VERIFIED BY: [Signature]

DATE: 30 September 2015

DIKAM: [Signature]

DATE: 2016/03/18

PA-09 (LS): LIST OF RETURNABLE DOCUMENTS

Property description: SASSA: VREDENDAL LOCAL OFFICE: OPEN TENDER PROCEDURE TO PROCURE NEW OFFICE ACCOMMODATION FOR A PERIOD OF FIVE (5) YEARS: LETTABLE GUIDELINE: 593,75M ² AND 8 PARKING BAYS (UNDER COVER SECURED PARKING BAYS)	Property Manager: A. FITOLI	Receipt Number:
	Bid / Quote no.: CPTL14/23	

1. THE BIDDER MUST COMPLETE THE FOLLOWING RETURNABLE DOCUMENTS:

(Bidders may use the "Returnable document" column to confirm documents have been completed and returned by inserting a tick)

Bid Document Name:	Number of Pages:	Returnable document:
PA-04 (LS): NOTICE AND INVITATION TO BID (Inclusive of Client Needs Assessment)	8 Pages	<input type="checkbox"/>
PA-09 (LS): LIST OF RETURNABLE DOCUMENTS	2 Pages	<input type="checkbox"/>
PA-10 (LS): IMPORTANT CONDITIONS OF BID	1 Pages	<input type="checkbox"/>
PA-11: BIDDERS DISCLOSURE	3 Pages	<input type="checkbox"/>
PA-15.1: RESOLUTION OF BOARD OF DIRECTORS	2 Pages	<input type="checkbox"/>
PA-15.2: RESOLUTION OF BOARD OF DIRECTORS TO ENTER INTO CONSORTIA OR JOINT VENTURES	2 Pages	<input type="checkbox"/>
PA-15.3: SPECIAL RESOLUTION OF CONSORTIA OR JOINT VENTURES	3 Pages	<input type="checkbox"/>
PA-16: PREFERENCE CERTIFICATE	6 Pages	<input type="checkbox"/>
STANDARD LEASE AGREEMENT (DRAFT) initial all pages	26 Pages	<input type="checkbox"/>
DPW-08.3(LS): BID OFFER - OFFICE ACCOMMODATION	3 Pages	<input type="checkbox"/>
DPW-11.1 (LS): SPECIFICATION ON MINIMUM REQUIREMENTS	3 Pages	<input type="checkbox"/>
DPW-12(LS): OCCUPATIONAL HEALTH AND SAFETY ACT CERTIFICATE	1 Pages	<input type="checkbox"/>
PA-29: CERTIFICATION OF INDEPENDENT BID DETERMINATION	4 Pages	<input type="checkbox"/>
PA-40: DECLARATION OF DESIGNATED GROUPS FOR PREFERENTIAL PROCUREMENT	2 Pages	<input type="checkbox"/>
CENTRAL SUPPLIER DATABASE TO BE ATTACHED OR NUMBER TO BE PROVIDED ANYWHERE IN THE BID DOCUMENT	Pages	<input type="checkbox"/>
	Pages	<input type="checkbox"/>
	Pages	<input type="checkbox"/>
	Pages	<input type="checkbox"/>
	Pages	<input type="checkbox"/>
	Pages	<input type="checkbox"/>
	Pages	<input type="checkbox"/>
	Pages	<input type="checkbox"/>
	Pages	<input type="checkbox"/>
	Pages	<input type="checkbox"/>

List of Returnable Documents: PA-09 (LS)

	Pages	<input type="checkbox"/>
--	-------	--------------------------

Name of Bidder	Signature	Date

PA-10 (LS): IMPORTANT CONDITIONS OF BID

Bid no:	CPTL14/23	Closing date:	18 August 2023
Advertising date:	28 July 2023	Validity period:	84 days

1. Bids that are not accompanied by written proof that the bidder is authorised to offer the accommodation for leasing will not be considered.

2. The only or lowest offer will not necessarily be accepted.

3. The Department of Public Works is the sole adjudicator of the suitability of the accommodation for the purpose for which it is required. The Department's decision in this regard will be final.

4. The Department of Public Works will in no way be responsible for or committed to negotiations that a user department may or might have conducted with a lessor or owner of a building.

5. It is a requirement that the accommodation offered, including all equipment and installations, must comply with the National Building Regulations and the requirements of the Occupational Health and Safety Act, 1993 (Act 85 of 1993), as amended. **A certificate to this effect must be issued.**

6. Drawings/ Architect's plans of the accommodation offered must be submitted. **In this regard it is a prerequisite that bidders should do a preliminary planning on the floor plans in accordance with the norm document.**

7. Lettable areas have to be determined in accordance with the **SAPOA** method for measuring floor areas in office buildings. The offer may not be considered if a certificate by an architect, certifying the area is not submitted.

8. The commencement date from which rental will be payable or the lease shall begin is subject to the approval of the Department of Public Works.

9. The lease agreement and payment of rental will commence from the date of occupancy. Rental will be adjusted on a yearly basis thereafter in accordance with an agreed upon escalation rate starting at the beginning of the second year.

10. No bids sent by facsimile will be accepted.

11. Bidders are welcome to be present at the opening of bids.

12. This annexure is part of the bid documentation and must be signed by the bidder and attached.

13. The bid forms must not be retyped or redrafted but photocopies may be used. Additional offers may be made but only on photocopies of the original documents or on other forms requisitioned. Additional offers are regarded as separate bids and must be treated as such by the bidder. The inclusion of various offers as part of a single submission in one envelope is not allowed. Additional offers must be submitted under separate cover.

14. The successful bidder will be responsible for the cost of alterations necessary to adapt the offered accommodation to the specific needs of the user department in accordance with the norm document and/or specified and minimum requirements.

15. Appended herewith is an example of a (PA-07): **Application for Tax Clearance Certificate** of which an original signed and stamped certificate should be obtained from the SA Revenue Services and submitted together with the completed bid document.

16. Failure to comply with the above-mentioned conditions may invalidate a bid.

BIDDER'S SIGNATURE:

Name of Bidder	Signature	Capacity	Date

PA-10: GENERAL CONDITIONS OF CONTRACT (GCC)

NOTES:

The purpose of this document is to:

- (i) Draw special attention to certain general conditions applicable to government bids, contracts and orders; and
- (ii) To ensure that clients be familiar with regard to the rights and obligations of all parties involved in doing business with government.

In this document words in the singular also mean in the plural and vice versa and words in the masculine also mean in the feminine and neuter.

- The General Conditions of Contract will form part of all bid documents and may not be amended.
- Special Conditions of Contract (SCC) relevant to a specific bid should be compiled separately for every bid (if applicable) and will supplement the General Conditions of Contract. Whenever there is a conflict, the provisions in the SCC shall prevail.

TABLE OF CLAUSES

1. Definitions
2. Application
3. General
4. Standards
5. Use of contract documents and information; inspection
6. Patent rights
7. Performance security
8. Inspections, tests and analysis
9. Packing
10. Delivery and documents
11. Insurance
12. Transportation
13. Incidental services
14. Spare parts
15. Warranty
16. Payment
17. Prices
18. Contract amendments
19. Assignment
20. Subcontracts
21. Delays in the supplier's performance
22. Penalties
23. Termination for default
24. Dumping and countervailing duties
25. Force Majeure
26. Termination for insolvency
27. Settlement of disputes
28. Limitation of liability
29. Governing language
30. Applicable law
31. Notices
32. Taxes and duties
33. National Industrial Participation Programme (NIPP)
34. Prohibition of restrictive practices

General Conditions of Contract

1. Definitions

1. The following terms shall be interpreted as indicated:

- 1.1. **"Closing time"** means the date and hour specified in the bidding documents for the receipt of bids.
- 1.2. **"Contract"** means the written agreement entered into between the purchaser and the supplier, as recorded in the contract form signed by the parties, including all attachments and appendices thereto and all documents incorporated by reference therein.
- 1.3. **"Contract price"** means the price payable to the supplier under the contract for the full and proper performance of his contractual obligations.
- 1.4. **"Corrupt practice"** means the offering, giving, receiving, or soliciting of any thing of value to influence the action of a public official in the procurement process or in contract execution.
- 1.5. **"Countervailing duties"** are imposed in cases where an enterprise abroad is subsidized by its government and encouraged to market its products internationally.
- 1.6. **"Country of origin"** means the place where the goods were mined, grown or produced or from which the services are supplied. Goods are produced when, through manufacturing, processing or substantial and major assembly of components, a commercially recognized new product results that is substantially different in basic characteristics or in purpose or utility from its components.
- 1.7. **"Day"** means calendar day.
- 1.8. **"Delivery"** means delivery in compliance of the conditions of the contract or order.
- 1.9. **"Delivery ex stock"** means immediate delivery directly from stock actually on hand.
- 1.10. **"Delivery into consignees store or to his site"** means delivered and unloaded in the specified store or depot or on the specified site in compliance with the conditions of the contract or order, the supplier bearing all risks and charges involved until the supplies are so delivered and a valid receipt is obtained.
- 1.11. **"Dumping"** occurs when a private enterprise abroad market its goods on own initiative in the RSA at lower prices than that of the country of origin and which have the potential to harm the local industries in the RSA.
- 1.12. **"Force majeure"** means an event beyond the control of the supplier and not involving the supplier's fault or negligence and not foreseeable. Such events may include, but is not restricted to, acts of the purchaser in its sovereign capacity, wars or revolutions, fires, floods, epidemics, quarantine restrictions and freight embargoes.
- 1.13. **"Fraudulent practice"** means a misrepresentation of facts in order to influence a procurement process or the execution of a contract to the detriment of any bidder, and includes collusive practice among bidders (prior to or after bid submission) designed to establish bid prices at artificial non-competitive levels and to deprive the bidder of the benefits of free and open competition.
- 1.14. **"GCC"** means the General Conditions of Contract.
- 1.15. **"Goods"** means all of the equipment, machinery, and/or other materials that the supplier is required to supply to the purchaser under the contract.

- 1.16. "Imported content" means that portion of the bidding price represented by the cost of components, parts or materials which have been or are still to be imported (whether by the supplier or his subcontractors) and which costs are inclusive of the costs abroad, plus freight and other direct importation costs such as landing costs, dock dues, import duty, sales duty or other similar tax or duty at the South African place of entry as well as transportation and handling charges to the factory in the Republic where the supplies covered by the bid will be manufactured.
- 1.17. "Local content" means that portion of the bidding price which is not included in the imported content provided that local manufacture does take place.
- 1.18. "Manufacture" means the production of products in a factory using labour, materials, components and machinery and includes other related value-adding activities.
- 1.19. "Order" means an official written order issued for the supply of goods or works or the rendering of a service.
- 1.20. "Project site" where applicable, means the place indicated in bidding documents.
- 1.21. "Purchaser" means the organization purchasing the goods.
- 1.22. "Republic" means the Republic of South Africa.
- 1.23. "SCC" means the Special Conditions of Contract.
- 1.24. "Services" means those functional services ancillary to the supply of the goods, such as transportation and any other incidental services, such as installation, commissioning, provision of technical assistance, training, catering, gardening, security, maintenance and other such obligations of the supplier covered under the contract.
- 1.25. "Written" or "in writing" means handwritten in ink or any form of electronic or mechanical writing.

2. Application

- 2.1. These general conditions are applicable to all bids, contracts and orders including bids for functional and professional services, sales, hiring, letting and the granting or acquiring of rights, but excluding immovable property, unless otherwise indicated in the bidding documents.
- 2.2. Where applicable, special conditions of contract are also laid down to cover specific supplies, services or works.
- 2.3. Where such special conditions of contract are in conflict with these general conditions, the special conditions shall apply.
- 3.1. Unless otherwise indicated in the bidding documents, the purchaser shall not be liable for any expense incurred in the preparation and submission of a bid. Where applicable a non-refundable fee for documents may be charged.
- 3.2. With certain exceptions, invitations to bid are only published in the Government Tender Bulletin. The Government Tender Bulletin may be obtained directly from the Government Printer, Private Bag X85, Pretoria 0001, or accessed electronically from www.treasury.gov.za

4. Standards

- 4.1. The goods supplied shall conform to the standards mentioned in the bidding documents and specifications.

5. Use of contract documents and information; inspection.

- 5.1. The supplier shall not, without the purchaser's prior written consent, disclose the contract, or any provision thereof, or any specification, plan, drawing, pattern, sample, or information furnished by or on behalf of the purchaser in connection therewith, to any person other than a person employed by the supplier in the performance of the contract. Disclosure to any such employed person shall be

made in confidence and shall extend only so far as may be necessary for purposes of such performance.

5.2. The supplier shall not, without the purchaser's prior written consent, make use of any document or information mentioned in GCC clause 5.1 except for purposes of performing the contract.

5.3. Any document, other than the contract itself mentioned in GCC clause 5.1 shall remain the property of the purchaser and shall be returned (all copies) to the purchaser on completion of the supplier's performance under the contract if so required by the purchaser.

5.4. The supplier shall permit the purchaser to inspect the supplier's records relating to the performance of the supplier and to have them audited by auditors appointed by the purchaser, if so required by the purchaser.

6.1. **6. Patent rights**
The supplier shall indemnify the purchaser against all third-party claims of infringement of patent, trademark, or industrial design rights arising from use of the goods or any part thereof by the purchaser.

7.1. **7. Performance security**
Within thirty (30) days of receipt of the notification of contract award, the successful bidder shall furnish to the purchaser the performance security of the amount specified in SCC.

7.2. The proceeds of the performance security shall be payable to the purchaser as compensation for any loss resulting from the supplier's failure to complete his obligations under the contract.

7.3. The performance security shall be denominated in the currency of the contract, or in a freely convertible currency acceptable to the purchaser and shall be in one of the following forms:

(a) a bank guarantee or an irrevocable letter of credit issued by a reputable bank located in the purchaser's country or abroad, acceptable to the purchaser, in the form provided in the bidding documents or another form acceptable to the purchaser; or

(b) a cashier's or certified cheque

7.4. The performance security will be discharged by the purchaser and returned to the supplier not later than thirty (30) days following the date of completion of the supplier's performance obligations under the contract, including any warranty obligations, unless otherwise specified in SCC.

8. Inspections, tests and analyses

8.1. All pre-bidding testing will be for the account of the bidder.

8.2. If it is a bid condition that supplies to be produced or services to be rendered should at any stage during production or execution or on completion be subject to inspection, the premises of the bidder or contractor shall be open, at all reasonable hours, for inspection by a representative of the Department or an organization acting on behalf of the Department.

8.3. If there are no inspection requirements indicated in the bidding documents and no mention is made in the contract, but during the contract period it is decided that inspections shall be carried out, the purchaser shall itself make the necessary payment arrangements, including payment arrangements with the testing authority concerned.

8.4. If the inspections, tests and analyses referred to in clauses 8.2 and 8.3 show the supplies to be in accordance with the contract requirements, the cost of the inspections, tests and analyses shall be defrayed by the purchaser.

8.5. Where the supplies or services referred to in clauses 8.2 and 8.3 do not comply with the contract requirements, irrespective of whether such supplies or services are accepted or not, the cost in connection with these inspections, tests or analyses shall be defrayed by the supplier.

13.2. (e) training of the purchaser's personnel, at the supplier's plant and/or on-site, in assembly, start-up, operation, maintenance, and/or repair of the supplied goods.

13.2. Prices charged by the supplier for incidental services, if not included in the contract price for the goods, shall be agreed upon in advance by the parties and shall not exceed the prevailing rates charged to other parties by the supplier for similar services.

14.1. As specified in SCC, the supplier may be required to provide any or all of the following materials, notifications, and information pertaining to spare parts manufactured or distributed by the supplier:

(a) such spare parts as the purchaser may elect to purchase from the supplier, provided that this election shall not relieve the supplier of any warranty obligations under the contract; and
(b) in the event of termination of production of the spare parts:

- (i) Advance notification to the purchaser of the pending termination, in sufficient time to permit the purchaser to procure needed requirements; and
- (ii) following such termination, furnishing at no cost to the purchaser, the blueprints, drawings, and specifications of the spare parts, if requested.

15. Warranty

15.1. The supplier warrants that the goods supplied under the contract are new, unused, of the most recent or current models, and that they incorporate all recent improvements in design and materials unless provided otherwise in the contract. The supplier further warrants that all goods supplied under this contract shall have no defect, arising from design, materials, or workmanship (except when the design and/or material is required by the purchaser's specifications) or from any act or omission of the supplier, that may develop under normal use of the supplied goods in the conditions prevailing in the country of final destination.

15.2. This warranty shall remain valid for twelve (12) months after the goods, or any portion thereof as the case may be, have been delivered to and accepted at the final destination indicated in the contract, or for eighteen (18) months after the date of shipment from the port or place of loading in the source country, whichever period concludes earlier, unless specified otherwise in SCC.

15.3. The purchaser shall promptly notify the supplier in writing of any claims arising under this warranty.

15.4. Upon receipt of such notice, the supplier shall, within the period specified in SCC and with all reasonable speed, repair or replace the defective goods or parts thereof, without costs to the purchaser.

15.5. If the supplier, having been notified, fails to remedy the defect(s) within the period specified in SCC, the purchaser may proceed to take such remedial action as may be necessary, at the supplier's risk and expense and without prejudice to any other rights which the purchaser may have against the supplier under the contract.

16. Payment

16.1. The method and conditions of payment to be made to the supplier under this contract shall be specified in SCC.

16.2. The supplier shall furnish the purchaser with an invoice accompanied by a copy of the delivery note and upon fulfillment of other obligations stipulated in the contract.

16.3. Payments shall be made promptly by the purchaser, but in no case later than thirty (30) days after submission of an invoice or claim by the supplier.

16.4. Payment will be made in Rand unless otherwise stipulated in SCC.

17. Prices

17.1. Prices charged by the supplier for goods delivered and services performed under the contract shall not vary from the prices quoted by the supplier in his bid, with the exception of any price adjustments authorized in SCC or in the purchaser's request for bid validity extension, as the case may be.

18. Contract amendments
18.1. No variation in or modification of the terms of the contract shall be made except by written amendment signed by the parties concerned.

19. Assignment
19.1. The supplier shall not assign, in whole or in part, its obligations to perform under the contract, except with the purchaser's prior written consent.

20. Subcontracts
20.1. The supplier shall notify the purchaser in writing of all subcontracts awarded under this contract if not already specified in the bid. Such notification, in the original bid or later, shall not relieve the supplier from any liability or obligation under the contract.

21. Delays in the supplier's performance
21.1. Delivery of the goods and performance of services shall be made by the supplier in accordance with the time schedule prescribed by the purchaser in the contract.

21.2. If at any time during performance of the contract, the supplier or its subcontractor(s) should encounter conditions impeding timely delivery of the goods and performance of services, the supplier shall promptly notify the purchaser in writing of the fact of the delay, its likely duration and its cause(s). As soon as practicable after receipt of the supplier's notice, the purchaser shall evaluate the situation and may at his discretion extend the supplier's time for performance, with or without the imposition of penalties, in which case the extension shall be ratified by the parties by amendment of contract.

21.3. No provision in a contract shall be deemed to prohibit the obtaining of supplies or services from a national department, provincial department, or a local authority.

21.4. The right is reserved to procure outside of the contract small quantities or to have minor essential services executed if an emergency arises, the supplier's point of supply is not situated at or near the place where the supplies are required, or the supplier's services are not readily available.

21.5. Except as provided under GCC Clause 25, a delay by the supplier in the performance of its delivery obligations shall render the supplier liable to the imposition of penalties, pursuant to GCC Clause 22, unless an extension of time is agreed upon pursuant to GCC Clause 21.2 without the application of penalties.

21.6. Upon any delay beyond the delivery period in the case of a supplies contract, the purchaser shall, without cancelling the contract, be entitled to purchase supplies of a similar quality and up to the same quantity in substitution of the goods not supplied in conformity with the contract and to return any goods delivered later at the supplier's expense and risk, or to cancel the contract and buy such goods as may be required to complete the contract and without prejudice to his other rights, be entitled to claim damages from the supplier.

22. Penalties

22.1. Subject to GCC Clause 25, if the supplier fails to deliver any or all of the goods or to perform the services within the period(s) specified in the contract, the purchaser shall, without prejudice to its other remedies under the contract, deduct from the contract price, as a penalty, a sum calculated on the delivered price of the delayed goods or unperformed services using the current prime interest rate calculated for each day of the delay until actual delivery or performance. The purchaser may also consider termination of the contract pursuant to GCC Clause 23.

23. Termination for default

23.1. The purchaser, without prejudice to any other remedy for breach of contract, by written notice of default sent to the supplier, may terminate this contract in whole or in part:

- (a) if the supplier fails to deliver any or all of the goods within the period(s) specified in the contract, or within any extension thereof granted by the purchaser pursuant to GCC Clause 21.2;
- (b) if the Supplier fails to perform any other obligation(s) under the contract; or
- (c) if the supplier, in the judgment of the purchaser, has engaged in corrupt or fraudulent practices in competing for or in executing the contract.

23.2.

In the event the purchaser terminates the contract in whole or in part, the purchaser may procure, upon such terms and in such manner as it deems appropriate, goods, works or services similar to those undelivered, and the supplier shall be liable to the purchaser for any excess costs for such similar goods, works or services. However, the supplier shall continue performance of the contract to the extent not terminated.

23.3

Where the purchaser terminates the contract in whole or in part, the purchaser may decide to impose a restriction penalty on the supplier by prohibiting such supplier from doing business with the public sector for a period of not exceeding 10 years.

23.4

If a purchaser intends imposing a restriction on a supplier or any person with the supplier, the supplier will be allowed a time period of not more than fourteen (14) days to provide why the envisaged restriction should not be imposed. Should the supplier fail to respond within the stipulated fourteen (14) days the purchaser may regard the intended penalty as not objected against and may impose it on the supplier.

23.5

Any restriction on any person by the Accounting Officer/ Authority will, at the discretion of the Accounting Officer/ Authority, also be applicable to any enterprise or any partner, manager, director or other person who wholly or partly exercises or exercised or may exercise control over the enterprise of the first-mentioned person, and with which the first-mentioned person, is or was in the opinion of the Accounting Officer/ Authority actively associated.

23.6

If a restriction is imposed, the purchaser must, within five (5) working days of such imposition, furnish The National Treasury, with the following information:

- i) The name and address of the supplier and/or person restricted by the purchaser;
- ii) The date of commencement of the restriction
- iii) The period of the restriction; and
- iv) The reasons for the restriction.

23.7

If a court of law convicts a person of an offence as contemplated in sections 12 or 13 of the Prevention and Combating of Corrupt Activities Act No. 12 of 2004, the court may also rule that such person's name be endorsed on the Register for Tender Defaulters. When a person's name has been endorsed on the Register, the person will be prohibited from doing business with the public sector for a period not less than five years and not more than ten years. The National Treasury is empowered to determine the period of restriction and each case will be dealt with on its merits. According to section 32 of the Act the Register must be open to the public. The Register can be perused on the National Treasury website.

24. Anti-dumping and countervailing duties and rights

24.1.

When, after the date of bid, provisional payments are required, or antidumping or countervailing duties are imposed, or the amount of a provisional payment or anti-dumping or countervailing right is increased in respect of any dumped or subsidized import, the State is not liable for any amount so required or imposed, or for the amount of any such increase. When, after the said date, such a provisional payment is no longer required or any such anti-dumping or countervailing right is abolished, or where the amount of such provisional payment or any such right is reduced, any such favourable difference shall on demand be paid forthwith by the contractor to the State or the State may deduct such amounts from moneys (if any) which may otherwise be due to the contractor in regard to supplies or services which he delivered or rendered, or is to deliver or render in terms of the contract or any other contract or any other amount which may be due to him.

- 25. Force Majeure**
- 25.1. Notwithstanding the provisions of GCC Clauses 22 and 23, the supplier shall not be liable for forfeiture of its performance security, damages, or termination for default if and to the extent that his delay in performance or other failure to perform his obligations under the contract is the result of an event of force majeure.
- 25.2. If a force majeure situation arises, the supplier shall promptly notify the purchaser in writing of such condition and the cause thereof. Unless otherwise directed by the purchaser in writing, the supplier shall continue to perform its obligations under the contract as far as is reasonably practical, and shall seek all reasonable alternative means for performance not prevented by the force majeure event.

26. Termination for insolvency

- 26.1. The purchaser may at any time terminate the contract by giving written notice to the supplier if the supplier becomes bankrupt or otherwise insolvent. In this event, termination will be without compensation to the supplier, provided that such termination will not prejudice or affect any right of action or remedy which has accrued or will accrue thereafter to the purchaser.

27. Settlement of Disputes

- 27.1. If any dispute or difference of any kind whatsoever arises between the purchaser and the supplier in connection with or arising out of the contract, the parties shall make every effort to resolve amicably such dispute or difference by mutual consultation.
- 27.2. If, after thirty (30) days, the parties have failed to resolve their dispute or difference by such mutual consultation, then either the purchaser or the supplier may give notice to the other party of his intention to commence mediation. No mediation in respect of this matter may be commenced unless such notice is given to the other party.
- 27.3. Should it not be possible to settle a dispute by means of mediation, it may be settled in a South African court of law.
- 27.4. Mediation proceedings shall be conducted in accordance with the rules of the procedure specified in the SCC.
- 27.5. Notwithstanding any reference to mediation and/or court proceedings herein,

28. Limitation of Liability

- 28.1. Except in cases of criminal negligence or willful misconduct, and in the case of infringement pursuant to Clause 6;
- (a) the supplier shall not be liable to the purchaser, whether in contract, tort, or otherwise, for any indirect or consequential loss or damage, loss of use, loss of production, or loss of profits or interest costs, provided that this exclusion shall not apply to any obligation of the supplier to pay penalties and/or damages to the purchaser; and
- (b) the aggregate liability of the supplier to the purchaser, whether under the contract, in tort or otherwise, shall not exceed the total contract price, provided that this limitation shall not apply to the cost of repairing or replacing defective equipment.

29. Governing language
 29.1. The contract shall be written in English. All correspondence and other documents pertaining to the contract that is exchanged by the parties shall also be written in English.

30. Applicable law
 30.1. The contract shall be interpreted in accordance with South African laws, unless otherwise specified in SCC.

31. Notices
 31.1. Every written acceptance of a bid shall be posted to the supplier concerned by registered or certified mail and any other notice to him shall be posted by ordinary mail to the address furnished in his bid or to the address notified later by him in writing and such posting shall be deemed to be proper service of such notice
 31.2. The time mentioned in the contract documents for performing any act after such aforesaid notice has been given, shall be reckoned from the date of posting of such notice.

32. Taxes and duties
 32.1. A foreign supplier shall be entirely responsible for all taxes, stamp duties, license fees, and other such levies imposed outside the purchaser's country.
 32.2. A local supplier shall be entirely responsible for all taxes, duties, license fees, etc., incurred until delivery of the contracted goods to the purchaser.

32.3. No contract shall be concluded with any bidder whose tax matters are not in order. Prior to the award of a bid the Department must be in possession of a tax clearance certificate, submitted by the bidder. This certificate must be an original issued by the South African

33. National Industrial Participation Programme (NIPP)

33.1. The NIP Programme administered by the Department of Trade and Industry shall be applicable to all contracts that are subject to the NIP obligation.

34. Prohibition of Restrictive Practices

34.1. In terms of section 4 (1) (b) (iii) of the Competition Act No. 89 of 1998, as amended, an agreement between, or concerted practice by, firms, or a decision by an association of firms, is prohibited if it is between parties in a horizontal relationship and if a bidder (s) is / are or a contractor(s) was / were involved in collusive bidding (or bid rigging).

34.2. If a bidder(s) or contractor(s), based on reasonable grounds or evidence obtained by the purchaser, has / have engaged in the restrictive practice referred to above, the purchaser may refer the matter to the Competition Commission for investigation and possible imposition of administrative penalties as contemplated in the Competition Act No. 89 of 1998.

34.3. If a bidder(s) or contractor(s), has / have been found guilty by the Competition Commission of the restrictive practice referred to above, the purchaser may, in addition and without prejudice to any other remedy provided for, invalidate the bid(s) for such item(s) offered, and / or terminate the contract in whole or part, and / or restrict the bidder(s) or contractor(s) from conducting business with the public sector for a period not exceeding ten (10) years and / or claim damages from the bidder(s) or contractor(s) concerned.

Name of Bidder	Signature	Date

PA-11: BIDDER'S DISCLOSURE

1. PURPOSE OF THE FORM

Any person (natural or juristic) may make an offer or offers in terms of this invitation to bid. In line with the principles of transparency, accountability, impartiality, and ethics as enshrined in the Constitution of the Republic of South Africa and further expressed in various pieces of legislation, it is required for the bidder to make this declaration in respect of the details required hereunder:

Where a person/s are listed in the Register for Tender Defaulters and / or the List of Restricted Suppliers, that person will automatically be disqualified from the bid process.

2. Bidder's declaration

2.1 Is the bidder, or any of its directors / trustees / shareholders / members / partners or any person having a controlling interest (1) in the enterprise, employed by the state?

YES / NO

2.1.1 If so, furnish particulars of the names, individual identity numbers, and, if applicable, state employee numbers of sole proprietor/ directors / trustees / shareholders / members/ partners or any person having a controlling interest in the enterprise, in table below.

Full Name	Identity Number	Name of State institution

(1) the power, by one person or a group of persons holding the majority of the equity of an enterprise, alternatively, the person/s having the deciding vote or power to influence or to direct the course and decisions of the enterprise.

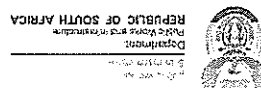

2.2 Do you, or any person connected with the bidder, have a relationship with any person who is employed by the procuring institution?

YES / NO

2.2.1 If so, furnish particulars:

.....
.....

2.3 Does the bidder or any of its directors / trustees / shareholders / members / partners or any person having a controlling interest in the enterprise have any interest in any other related enterprise whether or not they are bidding for this contract?

YES / NO

2.3.1 If so, furnish particulars:

.....
.....

3 DECLARATION

I, the undersigned, (name)....., in submitting the accompanying bid, do hereby make the following statements that I certify to be true and complete in every respect:

3.1 I have read and I understand the contents of this disclosure;

3.2 I understand that the accompanying bid will be disqualified if this disclosure is found not to be true and complete in every respect;

3.3 The bidder has arrived at the accompanying bid independently from, and without consultation, communication, agreement or arrangement with any competitor. However, communication between partners in a joint venture or consortium² will not be construed as collusive bidding.

3.4 In addition, there have been no consultations, communications, agreements or arrangements with any competitor regarding the quality, quantity, specifications, prices, including methods, factors or formulas used to calculate prices, market allocation, the intention or decision to submit the bid, bidding with the intention not to win the bid and conditions or delivery particulars of the products or services to which this bid invitation relates.

3.5 The terms of the accompanying bid have not been, and will not be, disclosed by the bidder, directly or indirectly, to any competitor, prior to the date and time of the official bid opening or of the awarding of the contract.

3.6 There have been no consultations, communications, agreements or arrangements made by the bidder with any official of the procuring institution in relation to this procurement process prior to and during the bidding process except to provide clarification on the bid submitted where so required by the institution; and the bidder was not involved in the drafting of the specifications or terms of reference for this bid.

2 Joint venture or Consortium means an association of persons for the purpose of combining their expertise, property, capital, efforts, skill and knowledge in an activity for the execution of a contract.

3.7 I am aware that, in addition and without prejudice to any other remedy provided to combat any restrictive practices related to bids and contracts, bids that are suspicious will be reported to the Competition Commission for investigation and possible imposition of administrative penalties in terms of section 59 of the Competition Act No 89 of 1998 and or may be reported to the National Prosecuting Authority (NPA) for criminal investigation and or may be restricted from conducting business with the public sector for a period not exceeding ten (10) years in terms of the Prevention and Combating of Corrupt Activities Act No 12 of 2004 or any other applicable legislation. I CERTIFY THAT THE INFORMATION FURNISHED IN PARAGRAPHS 1, 2 and 3 ABOVE IS CORRECT.

I ACCEPT THAT THE STATE MAY REJECT THE BID OR ACT AGAINST ME IN TERMS OF PARAGRAPH 6 OF PFMA SCM INSTRUCTION 03 OF 2021/22 ON PREVENTING AND COMBATING ABUSE IN THE SUPPLY CHAIN MANAGEMENT SYSTEM SHOULD THIS DECLARATION PROVE TO BE FALSE.

Signature
 Date
 Position
 Name of bidder

This form has been aligned with SBD4

PA-15.1: RESOLUTION OF BOARD OF DIRECTORS

RESOLUTION of a meeting of the Board of *Directors / Members / Partners of:

(Legally correct full name and registration number, if applicable, of the Enterprise)
 Held at _____ (place)
 on _____ (date)
RESOLVED that:

1. The Enterprise submits a Bid / Tender to the Department of Public Works in respect of the following project:

_____ (Project description as per Bid / Tender Document)

Bid / Tender Number: _____ (Bid / Tender Number as per Bid / Tender Document)

2. *Mr/Mrs/Ms: _____

in *his/her Capacity as: _____ (Position in the Enterprise)

and who will sign as follows: _____

be, and is hereby, authorised to sign the Bid / Tender, and any and all other documents and/or
 correspondence in connection with and relating to the Bid / Tender, as well as to sign any Contract, and
 any and all documentation, resulting from the award of the Bid / Tender to the Enterprise mentioned
 above.

	Name	Capacity	Signature
1			
2			
3			
4			
5			
6			
7			
8			
9			
10			
11			
12			
13			
14			
15			
16			



17		
18		
19		
20		

The bidding enterprise hereby absolves the Department of Public Works from any liability whatsoever that may arise as a result of this document being signed.

ENTERPRISE STAMP

Note:

1. * Delete which is not applicable.
2. NB: This resolution must, where possible, be signed by all the Directors / Members / Partners of the Bidding Enterprise.
3. In the event that paragraph 2 cannot be complied with, the resolution must be signed by Directors / Members / Partners holding a majority of the shares / ownership of the Bidding Enterprise (attach proof of shareholding / ownership here to).
4. Directors / Members / Partners of the Bidding Enterprise may alternatively appoint a person to sign this document on behalf of the Bidding Enterprise, which person must be so authorized by way of a duly completed power of attorney, signed by the Directors / Members / Partners holding a majority of the shares / ownership of the Bidding Enterprise (proof of shareholding / ownership and power of attorney are to be attached hereto).
5. Should the number of Directors / Members / Partners exceed the space available above, additional names and signatures must be supplied on a separate page.

PA-15.2: RESOLUTION OF BOARD OF DIRECTORS TO ENTER INTO CONSORTIA OR JOINT VENTURES

RESOLUTION of a meeting of the Board of *Directors / Members / Partners of:

 (Legally correct full name and registration number, if applicable, of the Enterprise)
 Held at _____ (place)
 on _____ (date)

RESOLVED that:

1. The Enterprise submits a Bid/Tender, in consortium/joint Venture with the following Enterprises:

 (List all the legally correct full names and registration numbers, if applicable, of the Enterprises forming the Consortium/joint Venture)

to the Department of Public Works in respect of the following project:

 (Project description as per Bid/Tender Document)

2. Bid / Tender Number: _____ (Bid / Tender Number as per Bid / Tender Document)
 *Mr/Mrs/Ms: _____
 in *his/her Capacity as: _____ (Position in the Enterprise)

and who will sign as follows: _____

be, and is hereby, authorised to sign a consortium/joint venture agreement with the parties listed under item 1 above, and any and all other documents and/or correspondence in connection with and relating to the consortium/joint venture, in respect of the project described under item 1 above.

3. The Enterprise accepts joint and several liability with the parties listed under item 1 above for the due fulfilment of the obligations of the joint venture deriving from, and in any way connected with, the Contract to be entered into with the Department in respect of the project described under item 1 above.

4. The Enterprise chooses as its *domicilium citandi et executandi* for all purposes arising from this joint venture agreement and the Contract with the Department in respect of the project under item 1 above:

Physical address: _____

 _____ (code)



Postal Address: _____
Telephone number: _____
Fax number: _____

(code)

	Name	Capacity	Signature
1			
2			
3			
4			
5			
6			
7			
8			
9			
10			
11			
12			
13			
14			
15			

The bidding enterprise hereby absolves the Department of Public Works from any liability whatsoever that may arise as a result of this document being signed

Note:

1. * Delete which is not applicable.
2. NB: This resolution must, where possible, be signed by all the Directors / Members / Partners of the Bidding Enterprise.
3. In the event that paragraph 2 cannot be complied with, the resolution must be signed by Directors / Members / Partners holding a majority of the shares / ownership of the Bidding Enterprise (attach proof of shareholding / ownership hereto).
4. Directors / Members / Partners of the Bidding Enterprise may alternatively appoint a person to sign this document on behalf of the Bidding Enterprise, which person must be so authorized by way of a duly completed power of attorney, signed by the Directors / Members / Partners holding a majority of the shares / ownership of the Bidding Enterprise (proof of shareholding / ownership and power of attorney are to be attached hereto).
5. Should the number of Directors / Members / Partners exceed the space available above, additional names and signatures must be supplied on a separate page.

ENTERPRISE STAMP



PA-15.3: SPECIAL RESOLUTION OF CONSORTIA OR JOINT VENTURES

RESOLUTION of a meeting of the duly authorised representatives of the following legal entities who have entered into a consortium/joint venture to jointly bid for the project mentioned below: (legally correct full names and registration numbers, if applicable, of the Enterprises forming a Consortium/Joint Venture)

1. _____

2. _____

3. _____

4. _____

5. _____

6. _____

7. _____

8. _____

Held at _____ (place)

on _____ (date)

RESOLVED that:

RESOLVED that:

A. The above-mentioned Enterprises submit a Bid in Consortium/Joint Venture to the Department of Public Works in respect of the following project:

(Project description as per Bid/Tender Document)

Bid / Tender Number: _____
(Bid / Tender Number as per Bid/Tender Document)

B.

*Mr/Mrs/Ms: _____

in *his/her Capacity as: _____ (Position in the Enterprise)

and who will sign as follows: _____

be, and is hereby, authorised to sign the Bid, and any and all other documents and/or correspondence in connection with and relating to the Bid, as well as to sign any Contract, and any and all documentation, resulting from the award of the Bid to the Enterprises in Consortium/Joint Venture mentioned above.

C.

The Enterprises constituting the Consortium/Joint Venture, notwithstanding its composition, shall conduct all business under the name and style of:

D.

The Enterprises to the Consortium/Joint Venture accept joint and several liability for the due fulfillment of the obligations of the Consortium/Joint Venture deriving from, and in any way connected with, the Contract entered into with the Department in respect of the project described under item A above.

E.

Any of the Enterprises to the Consortium/Joint Venture intending to terminate the consortium/joint venture agreement, for whatever reason, shall give the Department 30 days written notice of such intention. Notwithstanding such decision to terminate, the Enterprises shall remain jointly and severally liable to the Department for the due fulfillment of the obligations of the Consortium/Joint Venture as mentioned under item D above.

F.

No Enterprise to the Consortium/Joint Venture shall, without the prior written consent of the other Enterprises to the Consortium/Joint Venture and of the Department, cede any of its rights or assign any of its obligations under the consortium/joint venture agreement in relation to the Contract with the Department referred to herein.

G.

The Enterprises choose as the *domicilium citandi et executandi* of the Consortium/Joint Venture for all purposes arising from the consortium/joint venture agreement and the Contract with the Department in respect of the project under item A above:

Physical address:

_____ (Postal code)

Postal Address:

_____ (Postal code)

Telephone number:

Fax number:

PA-15.3: Special Resolution of Consortia or Joint Ventures

Signature	Capacity	Name
		1
		2
		3
		4
		5
		6
		7
		8
		9
		10
		11
		12
		13
		14
		15

The bidding enterprise hereby absolves the Department of Public Works & Infrastructure from any liability whatsoever that may arise as a result of this document being signed.

Note:

1. * Delete which is not applicable.
2. NB: This resolution must be signed by all the Duly Authorised Representatives of the Legal Entities to the consortium/joint venture submitting this tender, as named in item 2 of Resolution PA-15.2.
3. Should the number of the Duly Authorised Representatives of the Legal Entities joining forces in this tender exceed the space available above, additional names, capacity and signatures must be supplied on a separate page.
4. Resolution PA-15.2, duly completed and signed, from the separate Enterprises who participate in this consortium/joint venture, must be attached to this Special Resolution (PA-15.3).



PA-16: PREFERENCE POINTS CLAIM FORM IN TERMS OF THE PREFERENTIAL PROCUREMENT REGULATIONS 2022

This preference form must form part of all tenders invited. It contains general information and serves as a claim form for preference points for specific goals.

NB: BEFORE COMPLETING THIS FORM, TENDERERS MUST STUDY THE GENERAL CONDITIONS, DEFINITIONS AND DIRECTIVES APPLICABLE IN RESPECT OF THE TENDER AND PREFERENTIAL PROCUREMENT REGULATIONS, 2022

1. GENERAL CONDITIONS

- 1.1 The following preference point systems are applicable to invitations to tender:
 - the 80/20 system for requirements with a Rand value of up to R50 000 000 (all applicable taxes included); and
 - the 90/10 system for requirements with a Rand value above R50 000 000 (all applicable taxes included).

1.2 Preference Points System to be applied

(Tick whichever is applicable).

- The applicable preference point system for this tender is the 80/20 preference point system.
- The applicable preference point system for this tender is the 90/10 preference point system.
- Either the 90/10 or 80/20 preference point system will be applicable in this tender. The lowest/ highest acceptable tender will be used to determine the accurate system once tenders are received.

1.3 Points for this tender shall be awarded for:

- 1.3.1 Price; and
- 1.3.2 Specific Goals

1.4 The maximum points for this tender are allocated as follows:

CHOOSE APPLICABLE PREFERENCE POINT SCORING SYSTEM	
<input checked="" type="checkbox"/> 80/20	<input type="checkbox"/> 90/10
PRICE	80
SPECIFIC GOALS	20
Total points for Price and Specific Goals	100

1.5 Breakdown Allocation of Specific Goals Points
 1.5.1 For Procurement transactions with rand value greater than R2 000.00 and up to R1 Million (inclusive of all applicable taxes), the specific goals as listed in table 1 below are applicable.

All Acquisitions

Table 1

Serial No	Specific Goals	Preference Points allocated out of 20	Documentation to be submitted by bidders to validate their claim for points
1.	An EME or QSE which is at least 51% owned by black people	10	ID Copy Or SANAS Accredited BBBEE Certificate or sworn affidavit where applicable Or CSD Report Or CIPC (company registration)
2.	Located in a specific Local Municipality or District Municipality or Metro or Province area for work to be done or services to be rendered in that area	2	Office Municipal Rates Statement Or Permission To Occupy from local chief in case of rural areas (PTO) Or Lease Agreement
3.	An EME or QSE which is at least 51% owned by women	4	ID Copy Or CSD Report Or CIPC (company registration)

Serial No	Specific Goals	Preference Points allocated out of 20	Documentation to be submitted by bidders to validate their claim for points
4.	An EME or QSE which is at least 51% owned by people with disability	2	Medical Certificate Or South African Social Security Agency (SASSA) registration Or National Council for Persons with Physical Disability in South Africa registration (NCPDASA)
5.	An EME or QSE which is at least 51% owned by youth .	2	ID Copy Or CSD Report Or CIPC (company registration)

1.5.2 For procurement transactions with rand value greater than R1 Million and up to R50 Million (inclusive of all applicable taxes) the specific goals as listed in table 2 below are applicable:

All Acquisitions

Table 2

Serial No	Specific Goals	Preference Points allocated out of 20	Documentation to be submitted by bidders to validate their claim for points
1.	An EME or QSE or any entity which is at least 51% owned by Historically Disadvantaged Individuals (HDI)	10	ID Copy Or SANAS Accredited BBBEE Certificate or sworn affidavit where applicable Or CSD Report

Serial No	Specific Goals	Preference Points allocated out of 20	Documentation to be submitted by bidders to validate their claim for points
			Or CIPC (company registration)
2.	Located in a specific Local Municipality or District Municipality or Metro or Province area for work to be done or services to be rendered in that area	2	Office Municipal Rates Statement Or Permission To Occupy from local chief in case of rural areas (PTO) Or Lease Agreement
3.	An EME or QSE or any entity which is at least 51% owned by women	4	ID Copy Or CSD Report Or CIPC (company registration)
4.	An EME or QSE or any entity which is at least 51% owned by people with disability	2	Medical Certificate Or South African Social Security Agency (SASSA) registration Or National Council for Persons with Physical Disability in South Africa registration (NCPDSA)
5.	An EME or QSE or any entity which is at least 51% owned by youth.	2	ID Copy Or CSD Report Or CIPC (company registration)

1.5.3 For procurement transactions with rand value greater than R50 Million (Inclusive of all applicable taxes) the specific goals as listed in table 3 below are applicable
 All Acquisitions

Table 3

Serial No	Specific Goals	Preference Points allocated out of 10	Documentation to be submitted by bidders to validate their claim for points
1.	An EME or QSE or any entity which is at least 51% owned by Historically Disadvantaged Individuals (HDI)	4	ID Copy Or SANAS Accredited BBBEE Certificate or sworn affidavit where applicable Or CSD Report Or CIPC (company registration)
2.	Located in a specific Local Municipality or District Municipality or Metro or Province area for work to be done or services to be rendered in that area	2	Office Municipal Rates Statement Or Permission To Occupy from local chief in case of rural areas (PTO) Or Lease Agreement
3.	An EME or QSE or any entity which is at least 51% owned by women	2	ID Copy Or CSD Report Or CIPC (company registration)
4. <input type="checkbox"/>	An EME or QSE or any entity which is at least 51% owned by people with disability	2	Medical Certificate Or

- (a) **“tender”** means a written offer in the form determined by an organ of state in response to an invitation to provide goods or services through price quotations, competitive tendering process or any other method envisaged in legislation;
- (b) **“price”** means an amount of money tendered for goods or services, and includes all applicable taxes less all unconditional discounts;
- (c) **“rand value”** means the total estimated value of a contract in Rand, calculated at the time of bid invitation, and includes all applicable taxes;
- (d) **“tender for income-generating contracts”** means a written offer in the form determined by an organ of state in response to an invitation for the origination of income-generating contracts through any method envisaged in legislation that will result in a legal agreement between the organ of state and a third party that produces revenue for the organ of state, and includes, but is not limited to, leasing and disposal of assets and concession contracts, excluding direct sales and disposal of assets through public auctions; and
- (e) **“the Act”** means the Preferential Procurement Policy Framework Act, 2000 (Act No.

2. DEFINITIONS

- 1.6 Failure on the part of the tenderer to submit proof or documentation required in terms of this tender to claim points for specific goals, if the service provider/ tenderer did not submit proof or documentation required to claim for specific goals will be interpreted to mean that preference points for specific goals are not claimed.
- 1.7 The organ of state reserves the right to require of a service provider/tenderer, either before a tender is adjudicated or at any time subsequently, to substantiate any claim in regard to preferences, in any manner required by the organ of state.

Serial	Specific Goals	Preference Points allocated out of 10	Documentation to be submitted by bidders to validate their claim for points
5. <input type="checkbox"/>	An EMB or QSE or any entity which is at least 51% owned by youth. OR (only one specific goal is applicable between specific goal number 4 and specific goal number 5 under 90/10 Preference Point System)		South African Social Security Agency (SASSA) registration Or National Council for Persons with Physical Disability in South Africa registration (NCPDASA) Or ID Copy Or CSD Report Or CIPC (company registration)

4.2. In cases where organs of state intend to use Regulation 3(2) of the Regulations, which states that, if it is unclear whether the 80/20 or 90/10 preference point system applies, an organ of state must, in the tender documents, stipulate in the case of—

- (a) an invitation for tender for income-generating contracts, that either the 80/20 or 90/10 preference point system will apply and that the highest acceptable tender will be used to determine the applicable preference point system; or
 - (b) any other invitation for tender, that either the 80/20 or 90/10 preference point system will apply and that the lowest acceptable tender will be used to determine the applicable preference point system,
- then the organ of state must indicate the points allocated for specific goals for both the 90/10 and 80/20 preference point system.

Table 1: Specific goals for the tender and points claimed are indicated per the table below.

(Note to organs of state: Where either the 90/10 or 80/20 preference point system is applicable, corresponding points must also be indicated as such.

Note to tenders: The tenderer must indicate how they claim points for each preference point system.)

The specific goals allocated				Number of points allocated (90/10 system) (To be completed by the organ of state)	Number of points allocated (80/20 system) (To be completed by the organ of state)	Number of points claimed (90/10 system) (To be completed by the tenderer)	Number of points claimed (80/20 system) (To be completed by the tenderer)
1. An EME or QSE or any entity which is at least 51% owned by Historically Disadvantaged Individuals (HDI)	2	2	4				
3. An EME or QSE or any entity which is at least 51% owned by women	2	4					
2. Located in a specific Local Municipality or District Municipality or Metro or Province area for work to be done or services to be rendered in that area	2	2					
1. An EME or QSE or any entity which is at least 51% owned by Historically Disadvantaged Individuals (HDI)	4	10					

certify that the points claimed, based on the specific goals as advised in the tender, qualifies the company/ firm for the preference(s) shown and I acknowledge that:

i) The information furnished is true and correct;

ii) The preference points claimed are in accordance with the General Conditions as indicated in paragraph 1 of this form;

iii) In the event of a contract being awarded as a result of points claimed as shown in paragraphs 1.4 and 4.2, the contractor may be required to furnish documentary proof to the satisfaction of the organ of state that the claims are correct;

iv) If the specific goals have been claimed or obtained on a fraudulent basis or any of the conditions of contract have not been fulfilled, the organ of state may, in addition to any other remedy it may have –

(a) disqualify the person from the tendering process;

(b) recover costs, losses or damages it has incurred or suffered as a result of that person's conduct;

(c) cancel the contract and claim any damages which it has suffered as a result of having to make less favourable arrangements due to such cancellation;

(d) recommend that the tenderer or contractor, its shareholders and directors, or only the shareholders and directors who acted on a fraudulent basis, be restricted from obtaining business from any organ of state for a period not exceeding 10 years, after the *audi alteram partem* (hear the other side) rule has been applied; and

(e) forward the matter for criminal prosecution, if deemed necessary.

<p>.....</p> <p>SIGNATURE(S) OF TENDERER(S)</p> <p>.....</p>	<p>SURNAME AND NAME:</p> <p>DATE:</p> <p>ADDRESS:</p> <p>.....</p>
---	---



DPW – 08.3 (LS): BID OFFER – OFFICE ACCOMMODATION

Bid Offer – Office Accommodation: DPW-08.3 (LS)

Bid no:	CPL 14/23	Closing date:	18 August 2023
Advertising date:	28 July 2023	Validity period:	84 days

1. ACCOMMODATION PARTICULARS

Name of Company	
Erf no. / Name and address of building	
Title Deed Number of property offered (Provide certified copy of the Title Deed)	
Market value / Municipal valuation of building	m ²
Gross floor area of accommodation	
Date accommodation may be used	
Commencement date of lease	
Lease period	years
Option period	years
Value Added Tax Number	

1.1 OFFER: (COMPULSORY FOR ALL BIDDERS)

Offices	Stores	Parking
m ²	m ²	
Lettable area		
Parking bays		
Rental per month	R	R
VAT per month	R	R
Total per month	R	R
Tariffs	R /m ²	R /m ²
VAT	R /m ²	R /m ²
Total (1)	R /m ²	R /m ²
Escalation rate	%	%

Operating Costs (Provide details on what costs entail)	R	
VAT	R	
Total (2)	R	
Escalation rate	%	%

Operating Costs (Provide details on what costs entail)	R	
VAT	R	
Total (2)	R	
Escalation rate	%	%
Total (1+2)	R	R / day

Bid Offer – Office Accommodation: DPW-08.3 (LS)

Total bid price*		
Total bid price (VAT incl.)		
Total Bid price in words		

Minimum of R350/m ² (VAT excl.) for Tenant Installation (T.1.) excluding electrical/ mechanical/ structural items, which are Landlord's responsibility as well as providing certificates of compliance.	R	R	
--	---	---	--

2 RESPONSIBILITIES

Note: the state is not prepared to accept responsibility for services or costs involved within grey coloured columns. (Indicate where applicable)
 Note: the price stated in words will take precedence over the price in figures where figures are not clear
 Note: the total bid price should include the costs (offices, parking, stores, operating costs and escalation)
 Note: the award of the tender may be subjected to further price negotiation with the preferred tenderer(s).
 The negotiated and agreed price will be considered for acceptance as a firm and final offer.

2.1 Services	State	Lessor	Estimated cost per month
2.1.1 Water consumption			
2.1.2 Electricity consumption			
2.1.3 Sanitary services			
2.1.4 Refuse removal			
2.1.5 Domestic cleaning service			
2.1.6 Consumable Supplies			

2.2 Maintenance	State	Lessor	Estimated cost per month
2.2.1 Internal maintenance			
2.2.2 External			
2.2.3 Garden (if applicable)			
2.2.4 Air conditioning			
2.2.5 Lifts			
2.2.6 Floor covering: normal wear			

2.3 Rates and Insurance	State	Lessor	Estimated cost per month
2.3.1 Municipal rates & Increases			
2.3.2 Insurance & Increases			



Bid Offer – Office Accommodation: DPW-08.3 (LS)

2.3.3. ASRIA Insurance + Increase			
-----------------------------------	--	--	--

2.4 Other Responsibilities	State	Lessor	Estimated cost per month
2.4.1 Contract costs			
2.4.2 Stamp duty			
2.4.3 Firefighting equipment			
2.4.4 Cost of alterations			

Note: the state is not prepared to accept responsibility for services or costs involved within grey coloured columns. (Indicate where applicable)
 Note: the price stated in words will take precedence over the price in figures where figures are not clear
 Note: the total bid price should include the costs (offices, parking, stores, operating costs and escalation)
 Note: the award of the tender may be subjected to further price negotiation with the preferred tenderer(s).
 The negotiated and agreed price will be considered for acceptance as a firm and final offer.

3. NATIONAL BUILDING REGULATIONS:

Electricity Compliance Certificate	Yes <input type="checkbox"/> No <input type="checkbox"/>
Fire Regulation	Yes <input type="checkbox"/> No <input type="checkbox"/>
Accessibility Regulation	Yes <input type="checkbox"/> No <input type="checkbox"/>
Health and Safety Regulation	Yes <input type="checkbox"/> No <input type="checkbox"/>

4. PARTICULARS FOR PAYMENT OF RENTAL:

Person/Organisation to whom cheque must be issued	
Postal address	
Telephone no.	
Cell. No.	
e-mail address	

5. INCOME TAX REFERENCE NUMBER:

INCOME TAX REFERENCE NUMBER (in terms of Section 69 of the Income Tax Act, 1962 (Act 58 of 1962) as amended)	
--	--

Signature of Owner / Duly Authorised Representative	Date

Note: the state is not prepared to accept responsibility for services or costs involved within grey coloured columns. (Indicate where applicable)
 Note: the price stated in words will take precedence over the price in figures where figures are not clear
 Note: the total bid price should include the costs (offices, parking, stores, operating costs and escalation)
 Note: the award of the tender may be subjected to further price negotiation with the preferred tenderer(s).
 The negotiated and agreed price will be considered for acceptance as a firm and final offer.

DPW-11.1 (LS): SPECIFICATION ON MINIMUM REQUIREMENTS – OFFICE ACCOMMODATION

SPECIFICATION FOR MINIMUM REQUIREMENTS AND FINISHES TO WHICH THE BUILDING MUST COMPLY

1. **GENERAL:**
 - (a) This specification forms part of the written offer of the bidder and must be initiated and submitted with all other documents.
 - (b) Any requirements laid down in this specification shall be considered as supplementary to those set out in the written offer of the bidder and on the drawings. The fact that the Department checked the documentation and its acceptance thereof does not exempt the bidder from his responsibilities with regard to the fulfillment of the requirements of this specification.

2. **CONSTRUCTION AND APPEARANCE OF BUILDING:**

The design, construction and appearance of the building, including the internal and external finishes shall be of a standard acceptable to the Department of Public Works. The building must comply with the National Building Regulations as proclaimed by the National Building Regulations and Building Standards Act 1977 (Act 103 of 1977) as well as the Occupational Health and Safety Act, 1993 (Act 85 of 1993), as amended. The building shall be fully accessible to the disabled and the facilities must be provided as required by the Occupational Health and Safety Act, 1993 (Act 85 of 1993). A certificate to this effect must be submitted.
3. **SECURITY:**

The following security measures shall be complied with:

 - (a) All entrances to the building, which shall be limited to the minimum, must afford entry through one or more access control points.
 - (b) External walls of all floors, up to at least 1 metre above floor level, shall be of a heavyweight structure such as 220mm thick brick or 190mm thick concrete.

4. **RECORD ROOMS:**
 - (a) Record rooms shall be rooms with category 1 record room doors which can be opened from both sides and which comply with SABS Specification 949. Record room walls shall be of masonry of not less than 220mm thick or of concrete of not less than 150mm thick or of such structure approved by the Department of Public Works.
 - (b) Record rooms may have no external windows and all ventilation openings in the walls shall be fitted with fire dampers approved by the Fire Prevention Officer of the Department of Public Works.
 - (c) All keys shall be handed over to the Department of Public Works.
5. **ROOM AREAS AND PARTITIONS:**

Partition walls shall be used to divide the total floor area of the building into office and other areas required. The walls shall have a noise reduction factor of not less than 45 dB within a range of 100 to 1000 hertz. The factor has a bearing on complete wall sections including glass and doors if any.
6. **PASSAGE WIDTH:**

As a general standard an average passage width with a minimum of 1.5m over short distances shall be provided. Where certain functions within the building necessitate wider passages those specific areas will be identified and the passage width specified as part of the accommodation particulars.
7. **FLOOR TO CEILING HEIGHTS:**

A clear floor to ceiling height of as close as possible to 2.7m throughout shall be maintained in all general areas of the building. Where a building necessitates a higher floor to ceiling height, the specific areas will be identified and the height specified as part of the accommodation particulars. Conduits, water pipes, air ducts and other services shall not be visible underneath the ceiling in offices and public areas.
8. **DOORS, LOCKS AND KEYS:**





152. Females – staff and public
One WC (Water Closet) for every 10 persons to a total of 60 and thereafter one for every 20 additional persons or part thereof. One wash hand basin for every two WCs.

153. Physically challenged persons
Toilet facilities for physically challenged persons have to be provided according to norms and standards.

16. MATERIAL AND FINISHES:

(a) All walls and ceilings, whether painted or finished otherwise, shall be of a neutral colour.

(b) Walls of tea kitchens, stairs, entrance halls and toilets shall be washable and hardwearing and acceptable to the Department of Public Works.

17. INSPECTION:

The Department of Public Works considers it a condition of contract that in consultation with the lessor and with reasonable frequency during the process of refurbishment its inspector shall be given access to the building that he wishes to see. The inspector's approval of any part of the building does not exempt the owner from complying with any of these minimum standard requirements. A deviation from the minimum requirements may only be allowed with written permission from the Department of Public Works.

DPW-12 (LS): COMPLIANCE WITH ALL THE ACTS, REGULATIONS AND BY-LAWS GOVERNING THE BUILT ENVIRONMENT CERTIFICATE

Bid no:	CPTL14/23	Closing date:	18 August 2023
Advertising date:	28 July 2023	Validity period:	84

COMPLIANCE WITH ALL THE ACTS, REGULATIONS AND BY-LAWS GOVERNING THE BUILT ENVIRONMENT

I, _____, duly authorised to represent

_____ (the bidders name) acknowledge that I as

the property in question) complies in every respect with the requirements of the following Acts, Regulations and By - Laws:

- (i) Occupational Health and Safety Act, 1993. (Act 85 of 1993)
 - (ii) The National Building Regulations and Building Standards Act, 1977 (Act 103 of 1977)
 - (iii) The Municipal by-laws and any special requirements of the local supply authority.
 - (iv) The local fire regulations, to guarantee/ensure the health and safety of all State employees occupying this/these premises and the public visiting the premises for business or other purposes.
- I furthermore agree to advise the Department of Public Works immediately in writing of any reason I am unable to perform in terms of this agreement and to apply the necessary corrective measures.

Name owner / authorised representative	Signature	Date

1. WITNESS:

Name of witness	Signature	Date

2. WITNESS:

Name of witness	Signature	Date

PA- 29: CERTIFICATION OF INDEPENDENT BID DETERMINATION

Project title: SASSA: VREDENDAL LOCAL OFFICE: OPEN TENDER PROCEDURE TO PRODUCE NEW OFFICE ACCOMMODATION FOR A PERIOD OF FIVE (5) YEARS: LETTABLE GUIDELINE: 593,75M² AND 8 PARKING BAYS (UNDER COVER SECURED PARKING BAYS)	Bid no: CPTL14/23	Reference no:
--	-----------------------------	----------------------

INTRODUCTION

1. This PA-29 [Certificate of Independent Bid Determination] must form part of all bids¹ invited.
2. Section 4 (1) (b) (iii) of the Competition Act No. 89 of 1998, as amended, prohibits an agreement between, or concerted practice by, firms, or a decision by an association of firms, if it is between parties in a horizontal relationship and if it involves collusive bidding (or bid rigging).² Collusive bidding is a *per se* prohibition meaning that it cannot be justified under any grounds.
3. Treasury Regulation 16A9 prescribes that accounting officers and accounting authorities must take all reasonable steps to prevent abuse of the supply chain management system and authorizes accounting officers and accounting authorities to:
 - a. disregard the bid of any bidder if that bidder, or any of its directors have abused the institution's supply chain management system and or committed fraud or any other improper conduct in relation to such system.
 - b. cancel a contract awarded to a supplier of goods and services if the supplier committed any corrupt or fraudulent act during the bidding process or the execution of that contract.
4. This form (PA-29) serves as a certificate of declaration that would be used by institutions to ensure that, when bids are considered, reasonable steps are taken to prevent any form of bid-rigging.
5. In order to give effect to the above, the attached Certificate of Bid Determination (PA-29) must be completed and submitted with the bid:

¹ Includes price quotations, advertised competitive bids, limited bids and proposals.

² Bid rigging (or collusive bidding) occurs when businesses, that would otherwise be expected to compete, secretly conspire to raise prices or lower the quality of goods and / or services for purchasers who wish to acquire goods and / or services through a bidding process. Bid rigging is, therefore, an agreement between competitors not to compete.

CERTIFICATE OF INDEPENDENT BID DETERMINATION

I, the undersigned, in submitting the accompanying bid:

(Bid Number and Description)

in response to the invitation for the bid made by:

(Name of Institution)

do hereby make the following statements that I certify to be true and complete in every respect:

I certify, on behalf of: _____ that:

(Name of Bidder)

1. I have read and I understand the contents of this Certificate.

2. I understand that the accompanying bid will be disqualified if this Certificate is found not to be true and complete in every respect.

3. I am authorized by the bidder to sign this Certificate, and to submit the accompanying bid, on behalf of the bidder.

4. Each person whose signature appears on the accompanying bid has been authorized by the bidder to determine the terms of, and to sign the bid, on behalf of the bidder.

5. For the purposes of this Certificate and the accompanying bid, I understand that the word "competitor" shall include any individual or organization, other than the bidder, whether or not affiliated with the bidder, who:

(a) has been requested to submit a bid in response to this bid invitation;

(b) could potentially submit a bid in response to this bid invitation, based on their qualifications, abilities or experience; and

(c) provides the same goods and services as the bidder and/or is in the same line of business as the bidder.



6. The bidder has arrived at the accompanying bid independently from, and without consultation, communication, agreement or arrangement with any competitor. However communication between partners in a joint venture or consortium³ will not be construed as collusive bidding.

7. In particular, without limiting the generality of paragraphs 6 above, there has been no consultation, communication, agreement or arrangement with any competitor regarding:

- (a) prices;
- (b) geographical area where product or service will be rendered (market allocation)
- (c) methods, factors or formulas used to calculate prices;
- (d) the intention or decision to submit or not to submit, a bid;
- (e) the submission of a bid which does not meet the specifications and conditions of the bid; or
- (f) bidding with the intention not to win the bid.

8. In addition, there have been no consultations, communications, agreements or arrangements with any competitor regarding the quality, quantity, specifications and conditions or delivery particulars of the products or services to which this bid invitation relates.

9. The terms of the accompanying bid have not been, and will not be, disclosed by the bidder, directly or indirectly, to any competitor, prior to the date and time of the official bid opening or of the awarding of the contract.

I am aware that, in addition and without prejudice to any other remedy provided to combat any restrictive practices related to bids and contracts, bids that are suspicious will be reported to the Competition Commission for investigation and possible imposition of administrative penalties in terms of section 59 of the Competition Act No 89 of 1998 and or may be reported to the National Prosecuting Authority (NPA) for criminal investigation and or may be restricted from conducting business with the public sector for a period not exceeding ten (10) years in terms of the Prevention and Combating of Corrupt Activities Act No 12 of 2004 or any other applicable legislation.

Name of Bidder	Signature	Date	Position

' Joint venture or Consortium means an association of persons for the purpose of combining their expertise, property, capital, efforts, skill and knowledge in an activity for the execution of a contract.



PA- 40: DECLARATION OF DESIGNATED GROUPS FOR PREFERENTIAL PROCUREMENT

Tender no: CPTL14/23

Name of Tenderer EME¹ QSE² Non EME/QSE (tick applicable box)

1. LIST ALL PROPRIETORS, MEMBERS OR SHAREHOLDERS BY NAME, IDENTITY NUMBER, CITIZENSHIP AND DESIGNATED GROUPS.

Name and Surname #	Identity/ Passport number and Citizenship##	Percentage owned	Black	Indicate if youth	Indicate if woman	Indicate if person with disability	Indicate if living in Rural (R) / Under Developed Area (UD) / Township (T) / Urban (U).	Indicate if military veteran
1.		%	<input type="checkbox"/> Yes <input type="checkbox"/> No	<input type="checkbox"/> Yes <input type="checkbox"/> No	<input type="checkbox"/> Yes <input type="checkbox"/> No	<input type="checkbox"/> Yes <input type="checkbox"/> No	<input type="checkbox"/> R <input type="checkbox"/> UD <input type="checkbox"/> T <input type="checkbox"/> U	<input type="checkbox"/> Yes <input type="checkbox"/> No
2.		%	<input type="checkbox"/> Yes <input type="checkbox"/> No	<input type="checkbox"/> Yes <input type="checkbox"/> No	<input type="checkbox"/> Yes <input type="checkbox"/> No	<input type="checkbox"/> Yes <input type="checkbox"/> No	<input type="checkbox"/> R <input type="checkbox"/> UD <input type="checkbox"/> T <input type="checkbox"/> U	<input type="checkbox"/> Yes <input type="checkbox"/> No
3.		%	<input type="checkbox"/> Yes <input type="checkbox"/> No	<input type="checkbox"/> Yes <input type="checkbox"/> No	<input type="checkbox"/> Yes <input type="checkbox"/> No	<input type="checkbox"/> Yes <input type="checkbox"/> No	<input type="checkbox"/> R <input type="checkbox"/> UD <input type="checkbox"/> T <input type="checkbox"/> U	<input type="checkbox"/> Yes <input type="checkbox"/> No
4.		%	<input type="checkbox"/> Yes <input type="checkbox"/> No	<input type="checkbox"/> Yes <input type="checkbox"/> No	<input type="checkbox"/> Yes <input type="checkbox"/> No	<input type="checkbox"/> Yes <input type="checkbox"/> No	<input type="checkbox"/> R <input type="checkbox"/> UD <input type="checkbox"/> T <input type="checkbox"/> U	<input type="checkbox"/> Yes <input type="checkbox"/> No
5.		%	<input type="checkbox"/> Yes <input type="checkbox"/> No	<input type="checkbox"/> Yes <input type="checkbox"/> No	<input type="checkbox"/> Yes <input type="checkbox"/> No	<input type="checkbox"/> Yes <input type="checkbox"/> No	<input type="checkbox"/> R <input type="checkbox"/> UD <input type="checkbox"/> T <input type="checkbox"/> U	<input type="checkbox"/> Yes <input type="checkbox"/> No
6.		%	<input type="checkbox"/> Yes <input type="checkbox"/> No	<input type="checkbox"/> Yes <input type="checkbox"/> No	<input type="checkbox"/> Yes <input type="checkbox"/> No	<input type="checkbox"/> Yes <input type="checkbox"/> No	<input type="checkbox"/> R <input type="checkbox"/> UD <input type="checkbox"/> T <input type="checkbox"/> U	<input type="checkbox"/> Yes <input type="checkbox"/> No
7.		%	<input type="checkbox"/> Yes <input type="checkbox"/> No	<input type="checkbox"/> Yes <input type="checkbox"/> No	<input type="checkbox"/> Yes <input type="checkbox"/> No	<input type="checkbox"/> Yes <input type="checkbox"/> No	<input type="checkbox"/> R <input type="checkbox"/> UD <input type="checkbox"/> T <input type="checkbox"/> U	<input type="checkbox"/> Yes <input type="checkbox"/> No
8.		%	<input type="checkbox"/> Yes <input type="checkbox"/> No	<input type="checkbox"/> Yes <input type="checkbox"/> No	<input type="checkbox"/> Yes <input type="checkbox"/> No	<input type="checkbox"/> Yes <input type="checkbox"/> No	<input type="checkbox"/> R <input type="checkbox"/> UD <input type="checkbox"/> T <input type="checkbox"/> U	<input type="checkbox"/> Yes <input type="checkbox"/> No
9.		%	<input type="checkbox"/> Yes <input type="checkbox"/> No	<input type="checkbox"/> Yes <input type="checkbox"/> No	<input type="checkbox"/> Yes <input type="checkbox"/> No	<input type="checkbox"/> Yes <input type="checkbox"/> No	<input type="checkbox"/> R <input type="checkbox"/> UD <input type="checkbox"/> T <input type="checkbox"/> U	<input type="checkbox"/> Yes <input type="checkbox"/> No
10.		%	<input type="checkbox"/> Yes <input type="checkbox"/> No	<input type="checkbox"/> Yes <input type="checkbox"/> No	<input type="checkbox"/> Yes <input type="checkbox"/> No	<input type="checkbox"/> Yes <input type="checkbox"/> No	<input type="checkbox"/> R <input type="checkbox"/> UD <input type="checkbox"/> T <input type="checkbox"/> U	<input type="checkbox"/> Yes <input type="checkbox"/> No
11.		%	<input type="checkbox"/> Yes <input type="checkbox"/> No	<input type="checkbox"/> Yes <input type="checkbox"/> No	<input type="checkbox"/> Yes <input type="checkbox"/> No	<input type="checkbox"/> Yes <input type="checkbox"/> No	<input type="checkbox"/> R <input type="checkbox"/> UD <input type="checkbox"/> T <input type="checkbox"/> U	<input type="checkbox"/> Yes <input type="checkbox"/> No
12.		%	<input type="checkbox"/> Yes <input type="checkbox"/> No	<input type="checkbox"/> Yes <input type="checkbox"/> No	<input type="checkbox"/> Yes <input type="checkbox"/> No	<input type="checkbox"/> Yes <input type="checkbox"/> No	<input type="checkbox"/> R <input type="checkbox"/> UD <input type="checkbox"/> T <input type="checkbox"/> U	<input type="checkbox"/> Yes <input type="checkbox"/> No

Where Owners are themselves a Company, Close Corporation, Partnership etc, identify the ownership of the Holding Company, together with Registration number
 ## State date of South African citizenship obtained (not applicable to persons born in South Africa)

¹ EME: Exempted Micro Enterprise
² QSE: Qualifying Small Business Enterprise

PA- 40: DECLARATION OF DESIGNATED GROUPS FOR PREFERENTIAL PROCUREMENT

Tender no: _____

2. DECLARATION:

The undersigned, who warrants that he/she is duly authorized to do so on behalf of the Tenderer, hereby confirms that:

- 1 The information and particulars contained in this Affidavit are true and correct in all respects;
- 2 The Broad-based Black Economic Empowerment Act, 2003 (Act 53 of 2003), Preferential Procurement Policy Framework Act, 2000 (Act 5 of 2000), the Preferential Procurement Regulations, 2017, National Small Business Act 102 of 1996 as amended and all documents pertaining to this Tender were studied and understood and that the above form was completed according to the definitions and information contained in said documents;
- 3 The Tenderer understands that any intentional misrepresentation or fraudulent information provided herein shall disqualify the Tenderer's offer herein, as well as any other tender offer(s) of the Tenderer simultaneously being evaluated, or will entitle the Employer to cancel any Contract resulting from the Tenderer's offer herein;
- 4 The Tenderer accepts that the Employer may exercise any other remedy it may have in law and in the Contract, including a claim for damages for having to accept a less favourable tender as a result of any such disqualification due to misrepresentation or fraudulent information provided herein;
- 5 Any further documentary proof required by the Employer regarding the information provided herein, will be submitted to the Employer within the time period as may be set by the latter;

Signed by the Tenderer

Name of representative	Signature	Date

2.2.2 The building **MUST** be available for occupation by the Department by no later than **four (04) months** after the award of tender and approved space planning . In the case of a vacant site, the building **MUST** be available for occupation by the Department by no later than **Twelve (16) months** after the award of tender (four (4) months to obtain the all necessary approvals from the Municipality and twelve (12) months to complete the construction of the building and to obtain Occupational Certificate).

2.2.1 If the parking provided is an off-site parking it should not be more than 100m to 200m from the building.

The space required is 593,75m² and 8 under cover, safe and secured parking bays for safe and secure Stand-alone building or Multi-tenanted building.

2.2 **For suitability**; the bidder must provide proof of the space required;

2.1 **For locality**; The bidder must attach a locality map depicting location of the building or land offered in the CBD of Vredendal.

The Department and the end user Department will physically verify the property.

2. BID EVALUATION

- 1.1 Copy of the founding statement (CK1), if the firm is a Close Corporation.
- 1.2 Articles of Agreement, (CM1) and shareholding certificates endorsed by an auditor if the firm is a Company for the bidding entity. If the property offered is held by the holding company which is not the tendering entity, the shareholding certificates of that holding entity must be submitted as well.
- 1.3 Articles of Association and shareholding certificate, endorsed by an auditor, if the firm as a private company (Pty) Ltd. If the property offered is held by the holding company which is not the tendering entity, the shareholding certificates of that holding entity must be submitted as well.
- 1.4 In the event of the bidder being a public company, a letter from their auditor, certifying their status as a public company and attached thereto, a copy of the bidder's Articles of Agreement.

The following documents should accompany the tender documentation.

1. DOCUMENTS TO BE SUBMITTED

SPECIAL CONDITIONS OF BID

Department:
Public Works and Infrastructure
REPUBLIC OF SOUTH AFRICA

public works
& Infrastructure



7.1 The contract duration is for a period of five (05) years.

7. DURATION OF CONTRACT

6.1 The escalation rate (percentage) must be market related.

6. PRICE ESCALATION

5.1 The Department shall not be liable in any manner in respect of any claims, damages, accidents and injuries to persons, property or rights or any other courses of civil or criminal action that may arise from the carrying out of this contract. The landlord shall insure his / her / their personnel and any plant, machinery or other mechanical or electronic equipment involved in the fulfilment of this contract and shall indemnify the Department against all risks or claims which may arise.

5. INSURANCE CLAIMS, ETC.

According to the specific goal in paragraph 5.1, item No. 2 of the PA04 LS (Notice and invitation to bid), no preference points will be allocated in the event that the EME or QSE or any Entity is not located in the Specific Local Municipality or District Municipality or Metro area or Province area for work to be done or services to be rendered in that area.

4. CLARIFICATION ON PARAGRAPH 5.1 INSPECTION OF THE SPECIFIC GOAL, ITEM NO. 2 OF THE PA04 LS (NOTICE AND INVITATION TO BID)

Valid SANAS accredited B-BBEE Certificate or valid Sworn Affidavit to be submitted for this bid must be in terms of the **Property Sector Code** and **not a Generic Certificate**. Submission of a Generic Certificate will result in the bid not being allocated preference points for specific goals.

3. BBBEE CERTIFICATE

2.3 **For zoning of the property:** The bidder must provide approved Town Planning Certificate or Zoning Certificate from the Local Municipality confirming zoning for commercial / business / offices.

2.2.5 The building must be fully accessible to the disabled and the facilities must be provided as required by the Occupational Health and Safety Act, 1993 (Act 85 of 1993).

2.2.4 The building must have a water tank with a minimum capacity of 10,000 litres to supply water to the building during water scarcity or outages.

2.2.3 The building must have a generator or alternative power supply with sufficient capacity to keep it fully operational during power outages/load shedding.

7.2 The Department reserves the right to consider the renewal of the lease, without going to an open bidding process.

8. DISPUTES

8.1 In the event that disputes cannot be resolved by internal systems, the disputes will be settled by means of an arbitration.

9. COMMUNICATION

9.1 The Department of Public Works and Infrastructure will under no circumstances take responsibility if a user department may or might have committed or negotiated with lessors or owners of a building outside its bidding processes.

10. OCCUPATION DATE

10.1 The building MUST be available for occupation by the Department by no later than four (04) months after the award of tender and approved space planning. In the case of a vacant site, the building MUST be available for occupation by the Department by no later than Twelve (16) months after the award of tender (four (4) months to obtain the all necessary approvals from the Municipality and twelve (12) months to complete the construction of the building and to obtain Occupational Certificate).

10.2 Furthermore, a finishing schedule is also required. (Refer to the DPW-11.1 LS form and the minimum technical requirements)

11. COMPLIANCE

11.1 All required building compliance certificates and maintenance contracts shall be issued to the Department 10 (ten) days before hand-over of the building. Non-compliance will lead to cancellation of the award. Certification must include, not limited to the following: Fire, Electrical, Roof, Institute of Plumbing SA, COC, Building Grade Certificate, Area Certificate or floor plans certified by a professional Architect, as well as air quality certificate, Borehole Beetle test.

11.2 The accommodation must comply with all existing Legislation and Regulations applicable to the Built Environment.

12. PRICE NEGOTIATION

If the price offered by a bidder scoring the highest points is not market related, the Department may not award the contract to that bidder. However,

(a) The Department may -
(i) negotiate a market-related price with the bidder scoring the highest points or cancel the tender;

(ii) If the first highest scoring bidder does not agree to a market-related price, the second highest scoring bidder will be considered or cancel the tender;

(iii) If the second highest bidder does not agree to market-related price the tender shall be cancelled.

(b) If a market-related price is not agreed as envisaged in paragraph (a) (iii), the Department **must** cancel the tender.

13. BUILDING OPERATING COSTS

13.1 The Department will be responsible for the operating costs that relate directly to its own tenancy activities and that, where applicable, are separately metered. The Department is prepared to incur the following operating costs:

- a) Water consumption;
- b) Electricity consumption;
- c) Refuse removal;
- d) Internal security;
- e) Internal cleaning and
- f) Consumable supplies.

13.2 The Department will not be responsible for any other operating costs.

13.3 The Department will not be responsible for the payment of rates and taxes as well as periodic increases thereof.

14. BUILDING MAINTENANCE COSTS

14.1 All maintenance shall be the responsibility of the landlord.

14.2 Other responsibilities between the landlord and the tenant will be stipulated in the lease agreement.

15 PENALTIES

- 15.1 The landlord shall be liable for any damages to the end user's equipment, machineries and vehicles that may occur as a result of poor or lack of maintenance of the building (e.g damages as a result roof leakages).
- 15.2 In light of the above (13.1) the landlord shall be responsible for the replacement cost as a result of the said damages.

Guidelines on the application of the SASSA corporate identity

CORPORATE BRANDING: Guidelines on the application of the SASSA corporate identity

SOUTH AFRICAN SOCIAL SECURITY AGENCY

sassa



Vision
A comprehensive social security service that assists people in being self-sufficient and supporting those in need

Mission
To manage quality social security services to eligible and potential beneficiaries effectively and efficiently

Values
The Agency, as a public entity, subscribes to values that promote democracy and a culture of respect for human rights.

- Social Cohesion
- Confidentiality
- Integrity
- Fairness
- Transparency
- Equity
- Customer Care-Centred Approach

Communication through signage creates a huge opportunity to build the SASSA brand. "Signage helps people identify, navigate, and understand environments" - Allan Jacobson

Signage

- Increase expression of the SASSA Brand
- Ensure easy identification, information and advertising of the SASSA Brand
- Create a uniform way of expressing the SASSA brand "spirit" across all its offices

Signage - considerations

- Signage must complement existing SASSA building Architecture and based on Interior Guidelines (whether interior or exterior)
- There should be maintenance plans linked with installation of signage over the long-term or post installation
- In certain municipal areas, there are zoning rules that apply. This must be noted and adhered to.
- Exterior signage must take into account pedestrians and vehicles passing the building
- Ensure high visibility, positioning, legibility and durability for impact

Our Name

In all respects, the organisation shall be known as the "South African Social Security Agency" and abbreviated "SASSA". This naming approach will help entrench the SASSA brand name and is critical marketing the organisation. Any abbreviated reference to the organisation will be "SASSA" (in caps) and not, for example, "the Agency". This name shall be at the front and back of every publication the organisation produces.

Why should SASSA strive for uniformity in environmental signage?

The aim of uniformity is to consistently promote a certain look and feel as the correct identity and apply this consistently to a point that it resonates with SASSA clients wherever the organisation is represented.

Our visual identity

Secondary logos apply only when it is difficult to make use of the primary logo, for example, for signage. All environmental signage for SASSA should use the horizontal logo and vertical versions of the logo.

Colour applications/Two Colour

The pay off line is unjustified and normally a double deck. Single Colour applications/Two Colour options. In cases where a full colour logo cannot be used, single/two color logo provide a viable options. Please note that this options is mainly in primary colours.

The aim of uniformity is to consistently promote a certain look and feel as the correct identity and apply this consistently to a point that it resonates with SASSA clients wherever the organisation is represented.

Environmental Signage

Secondary logos apply only when it is difficult to make use of the primary logo, for example, for signage. All environmental signage for SASSA should use the horizontal logo and vertical versions of the logo.

Signage - Payoff Invertograms

The pay off line is unjustified and normally a double deck. Single Colour applications/Two Colour options. In cases where a full colour logo cannot be used, single/two color logo provide a viable options. Please note that this options mainly in primary colours.

The use of SASSA Corporate Identity

All designs and displays at SASSA offices should prominently display its identity. All messaging should be approved by the Marketing and Communication Unit to ensure consistent application and compliance with set corporate identity standard and brand strategy.

Brand Endorsements

SASSA may not endorse a particular product or services at the expense of its identity, for example, displaying vendor machines in key SASSA areas.

The SASSA curve

The SASSA curve is a vital element of the visual identity and style for all SASSA products. This can be applied both in primary and secondary colours.

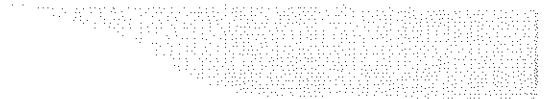

The SASSA left bracket and official font

The SASSA bracket [, which is normally placed on the left of a sentence/word/ design is also an important element of the SASSA house style. This should be used as prominently as possible. The official font (Body Text) for all SASSA documents is Arial.

The SASSA hands symbol

The SASSA hands "symbol" contain hands in a radial format. This can be utilised in restricted areas as watermarks. Hands should be utilised in various formats to compliment other visual design elements of the SASSA signature.



SASSA payoff line/tag line

The pay off line is unjustified and normally a double deck. The tagline is originally in Granjon Italic OSF font. In cases where this font is available, Arial - SASSA's official font - should be used.

*paying the right social grant, to the right person,
at the right time and place. N/ALOI*

The SASSA Primary Colour Palette is derived from our logo and should be used as specified above. It is the primary reproduction colour palette. Convert CMYK to RGB when required but align to pantone palette for consistency. Exact swatches should be utilised for exact colour matching SASSA promotional items, publications, etc

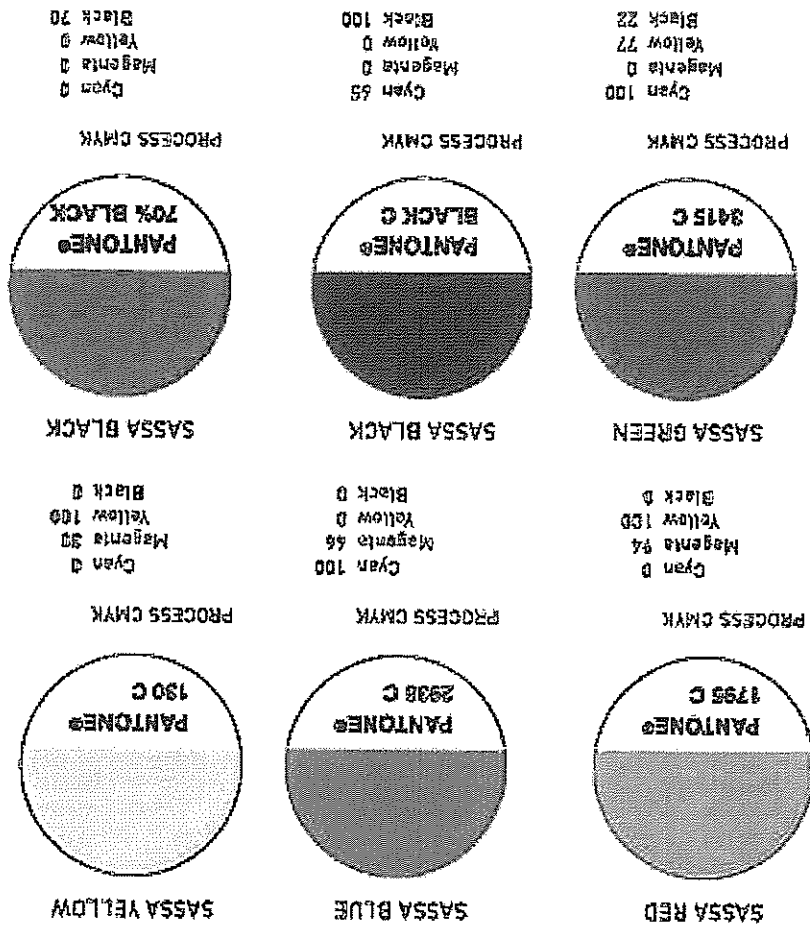

The SASSA Secondary Colour Palette uses earthy tones that complement our primary colour palette. The secondary colour palette/colours are restricted colours. These should be used as backgrounds and to add flavour and "freshness" to the SASSA work environment. The palette are also reserved for exterior and interior of SASSA buildings. The palette conveys a warm, caring, professional and approachable atmosphere in the SASSA office environment. Pantone 458C is used for all wall coatings, interior and exterior, completed by a dynamic Pantone 144C, Pantone 143 C or Pantone 504C.

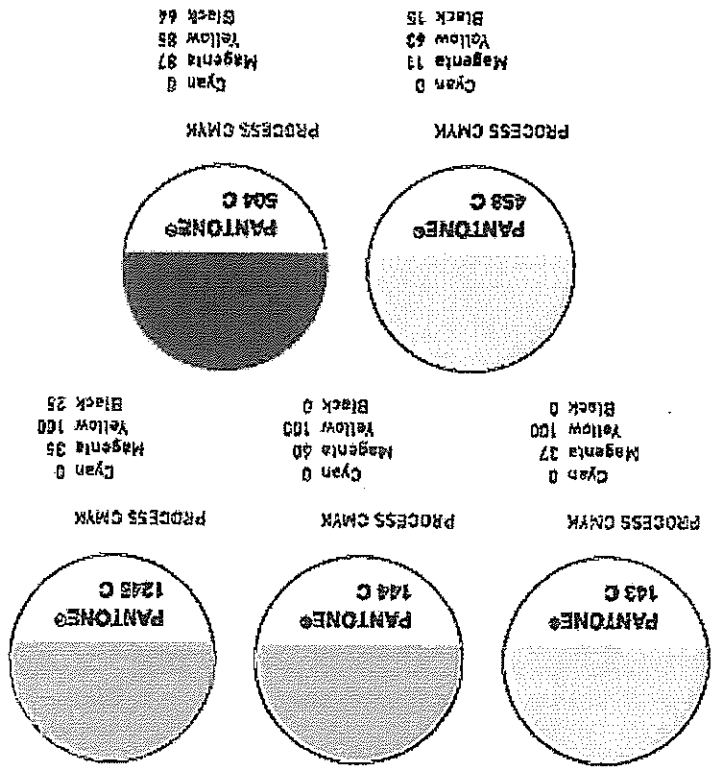

The secondary colour palette/colours are restricted colours. These should be used as backgrounds and to add flavour and "freshness" to designs/ artwork/ environment. These are also reserved for exterior and interior of SASSA buildings. Exact swatches should be utilised for exact colour matching SASSA promotional items, publications, etc.

SASSA Yellow & primary colour

This is the prominent colour of SASSA, for all designs, for example, as a curve on walls/signage



SASSA Orange

This colour should be used to highlight or emphasis



SASSA Browns and Maroons

These colours should be used as backgrounds and or highlighters, for example, for walls, ceilings and carpets and tiles



Complementary/neutral colours

Pantone 458 C SASSA Grey

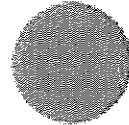

C: 0
M: 11
Y: 63
K: 15

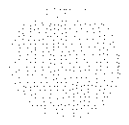

C: 0
M: 0
Y: 0
K: 70

The SASSA Yellow is the main (primary) colour for SASSA. This colour should be used as extensive as possible in all formats of products the organisation develops.

In portraying a professional image of SASSA, it is vital to create a work environment that exudes confidence and productivity. A warm and caring environment that consists of clean and simple lines is essential. The overall straw colour is Pantone 458C which allows for accessories to be in our vibrant primary palette thus tastefully lifting a look of feel environment. For furniture, Worktop surfaces are decorative laminate in Vancouver Maple 688, Underside finished with quality 0.3mm balancing backer, not paper.

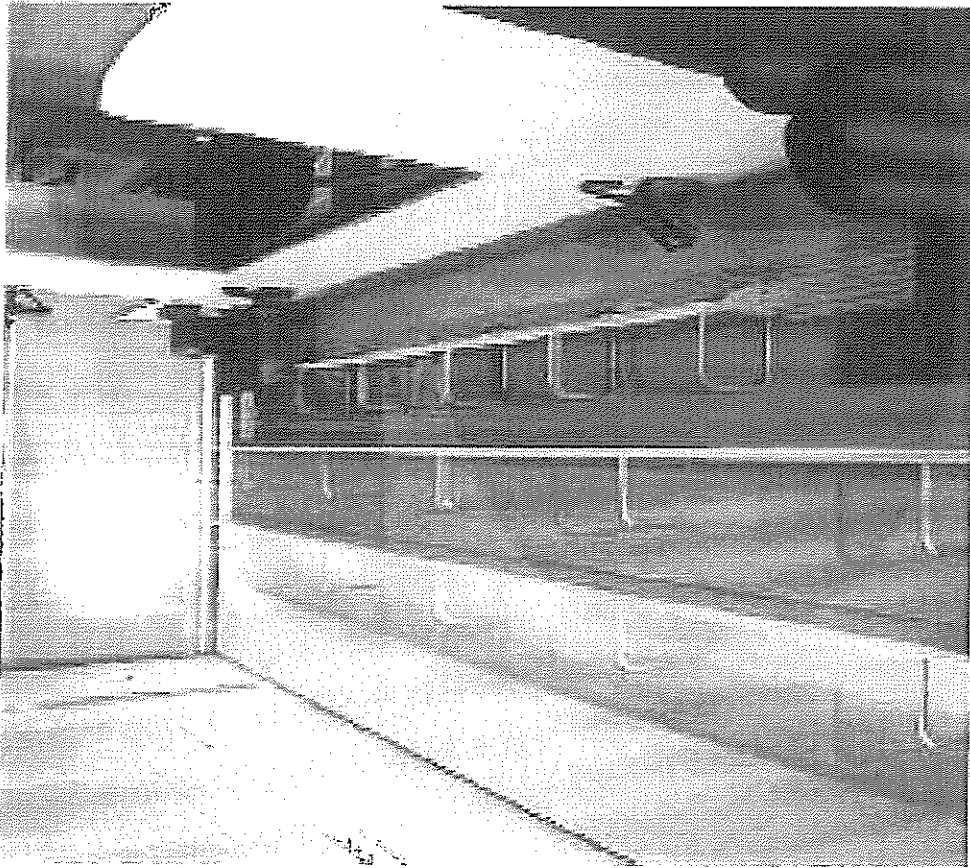

The shopfront illustrated is a typical example of application of elements of the SASSA corporate identity and serves as a guideline. Various factors must also be taken into account when applying signage, for example, visibility, size and traffic flow within the identified area. Thus, SASSA shopfronts should have: The SASSA identifier sign, the SASSA logo frosted on windows, and the SASSA curve in colour of frosted as indicated above.

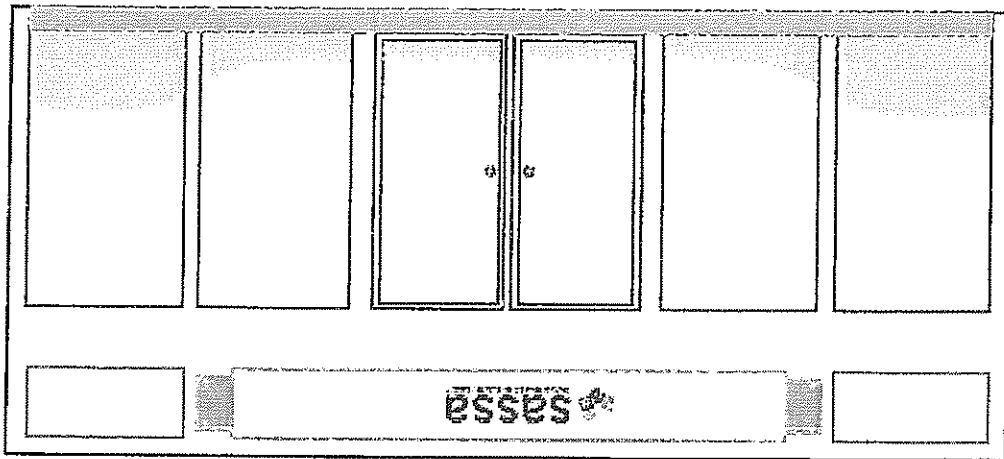

On the entrances of glass boardrooms the dynamic element of the SASSA corporate identity - the SASSA curve - is frosted and laminated on the glass. Furthermore, door and window frames should be aluminium/grey/silver. This includes door frames.

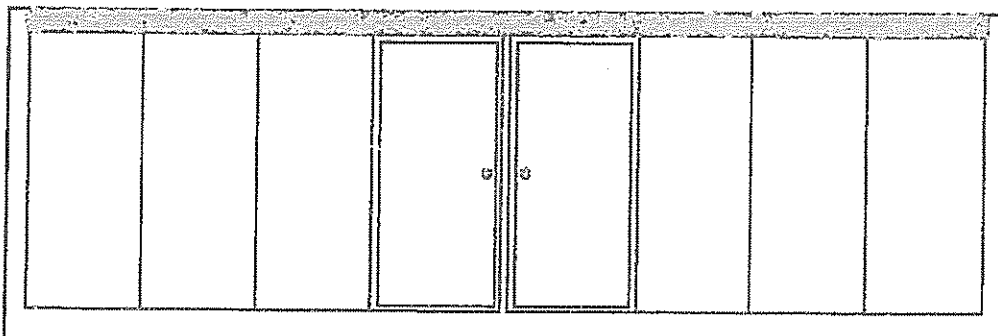

Window, door frames and skirtings should be grey aluminium/silver. Silver/grey blinds are also compulsory. The same applies to door handles. Prescribed door handles should be Antique Aluminium pull handle. Technical requirements are available from the Unit:Facilities Management.



All SASSA offices must be carpeted with 600 x 600 x 6 mm Bilgotex Red Oxide Point 920 tiles. The colour of the carpet tiles has been chosen to obscure any dirt while at the same time being hardworking and durable. The carpet tiles are to be used in high volume areas, for example, receptions.

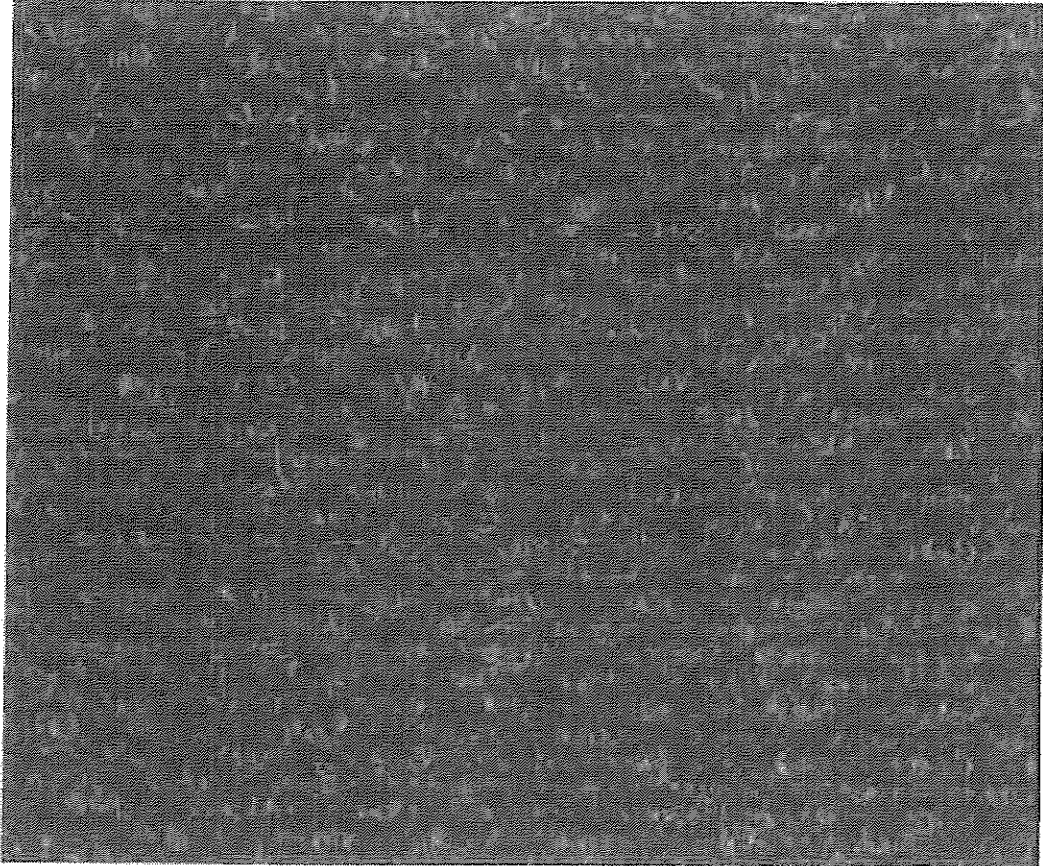

As with the SASSA furnisher, the wooden floor for SASSA offices is decorative laminate Vancouver Maple 688 and should be maintained to create a clean look. Wooden floors should be limited in short passages or pause areas. Wooden floor should not be used in workstations.

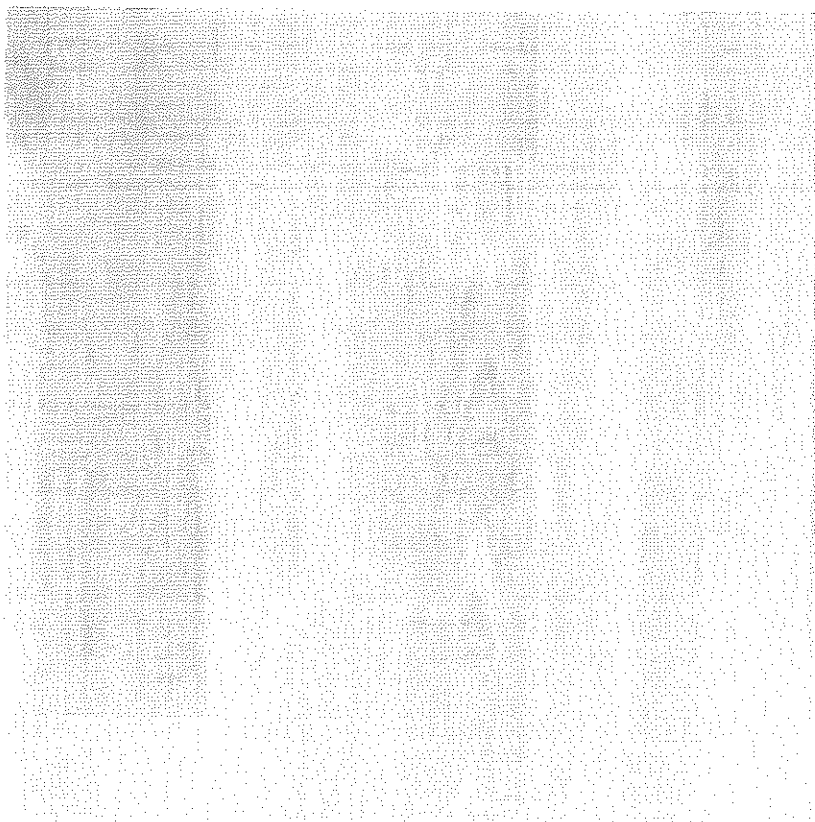

Ceramic tiles utilised for SASSA office floors is 300x300 x 2.5 MarleyFlex Beige (matching with Pantone 458C). This gives a dynamic and clean contemporary look for SASSA interiors, especially with a straight arrangement of tiles.

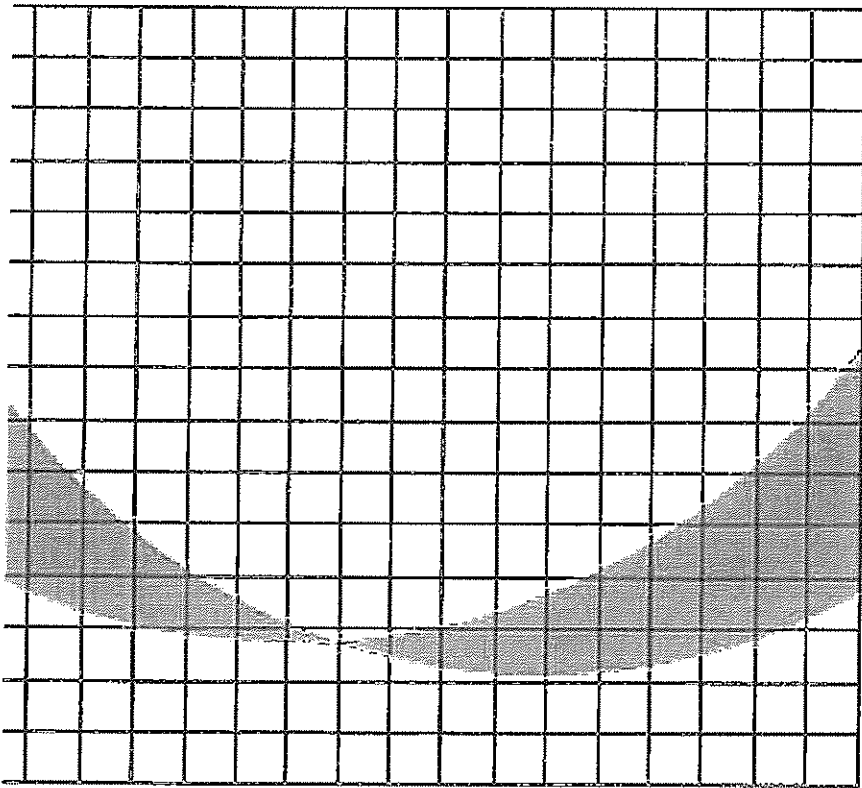

Ceramic tiles utilised for SASSA office floors is 300x300 x 2.5 MarleyFlex Beige (matching with Pantone 458C). This gives a dynamic and clean contemporary look for SASSA interiors, especially with a straight arrangement of tiles. A belt of Pantone 504C should be used above the Beige tiles as indicated above.



Skirting for SASSA is maple painted with high gloss emanel paint or aluminium. Timber skirting is visible to our customer, and has a very important role in creating overal ambience. Thus, the skirting has been designed in both maple, to match the SASSA furnislers and incorporates an aluminium runner to match the overall stainless steel looks. No skirtings should be used in toilets.

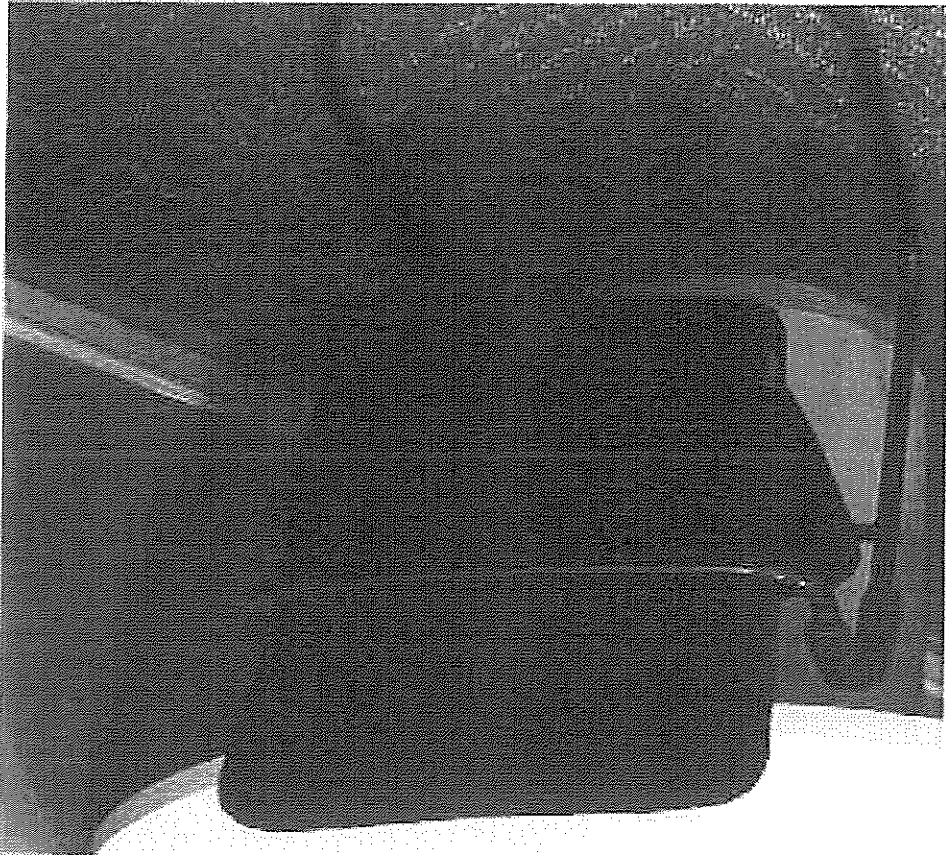

SASSA ceilings can either be plastered concrete or gypsum plastered-board or suspended ceilings. All plastered or board ceilings to be painted with white PVA paint.

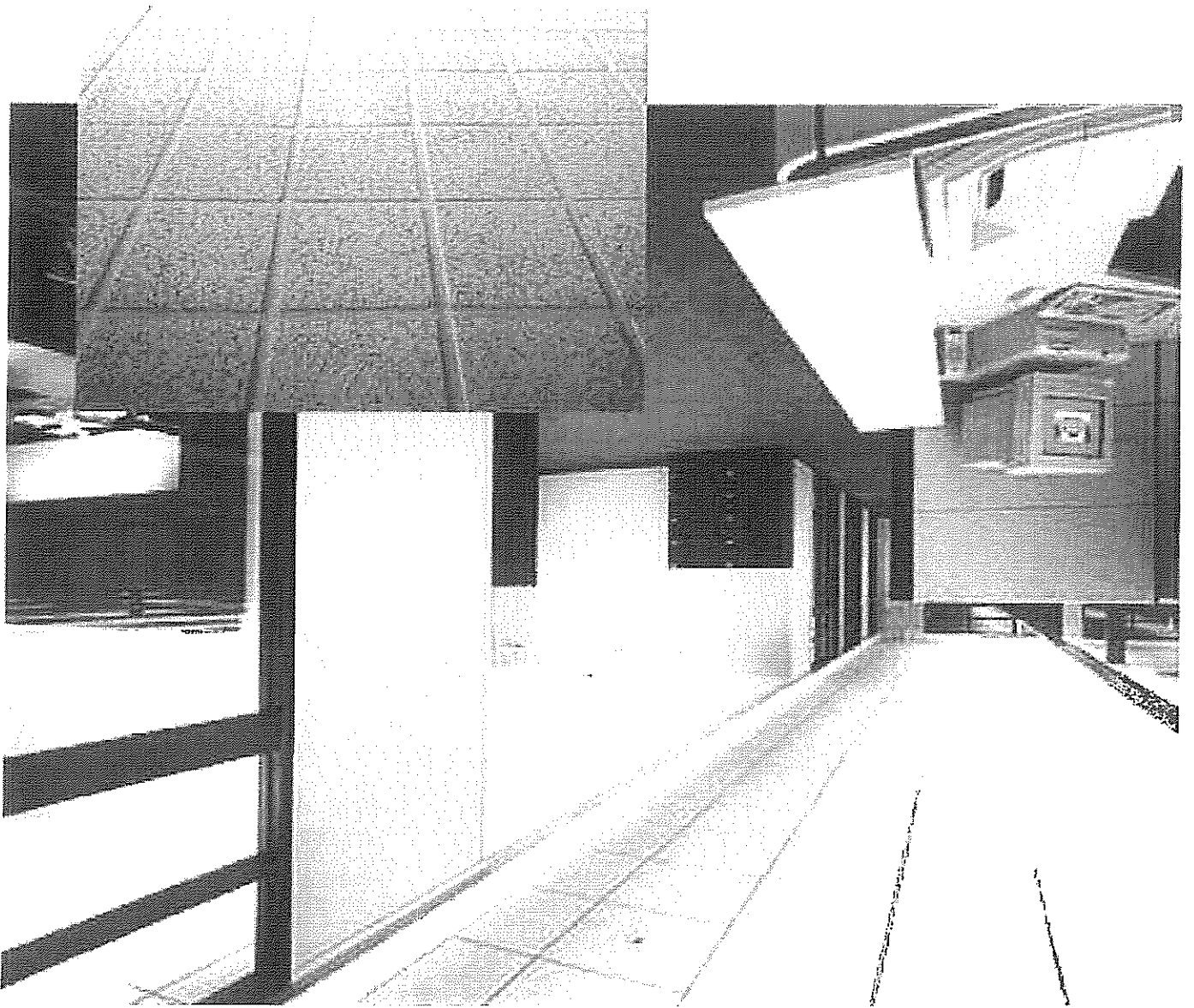

All interior walls are to be painted on Plascon Rice Paper VEL 45. All exterior walls are to be painted with Micatex Kalahari BBO 3110. These colours are within the SASSA Pantone 458C.

**Plascon
Rice Paper
VEL 45**

**Micatex
Kalahari
BBO 3110**

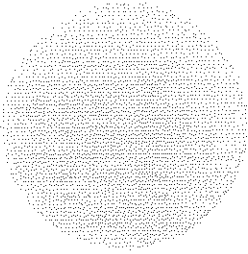

Lighting intensity to be a minimum 300 Lux on offices and 500 lux in public areas. To underside of ceiling fit 1200 flush recessed fluorescent light fitting with prismatic acrylic cover.

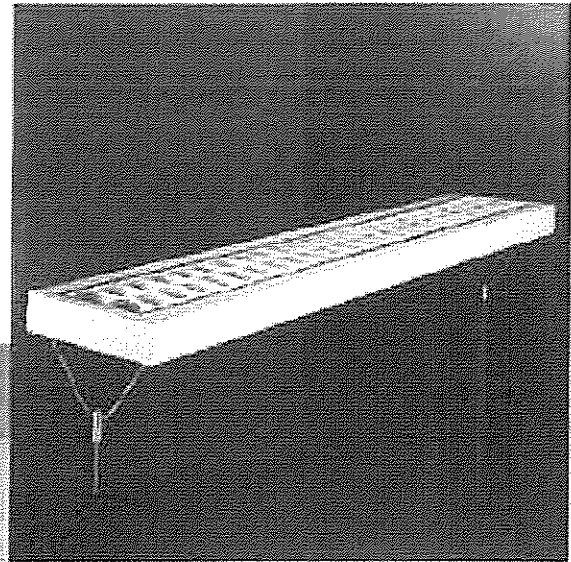
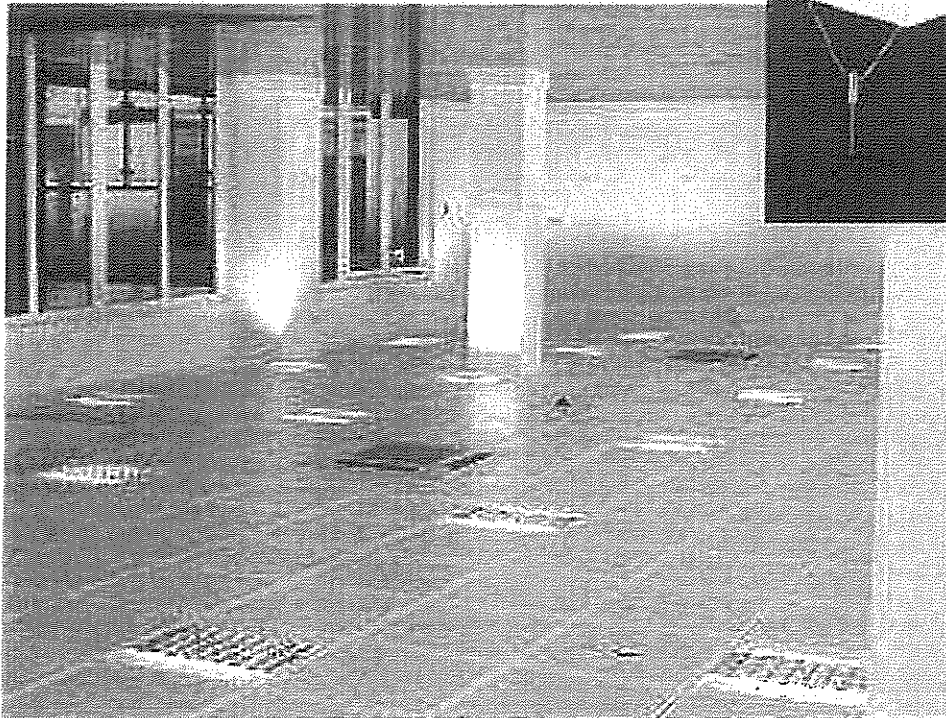

A steel bench should be used in all waiting areas due to its user-friendliness. For high volume areas, the three seater steel bench is easy to clean and look after and is a highly economical use of office space with great flexibility. This guide is also in line with the SASSA furnisher style and is simple to assemble and disassemble. Care must also be taken to ensure that broken steel benches are replaced and maintained.

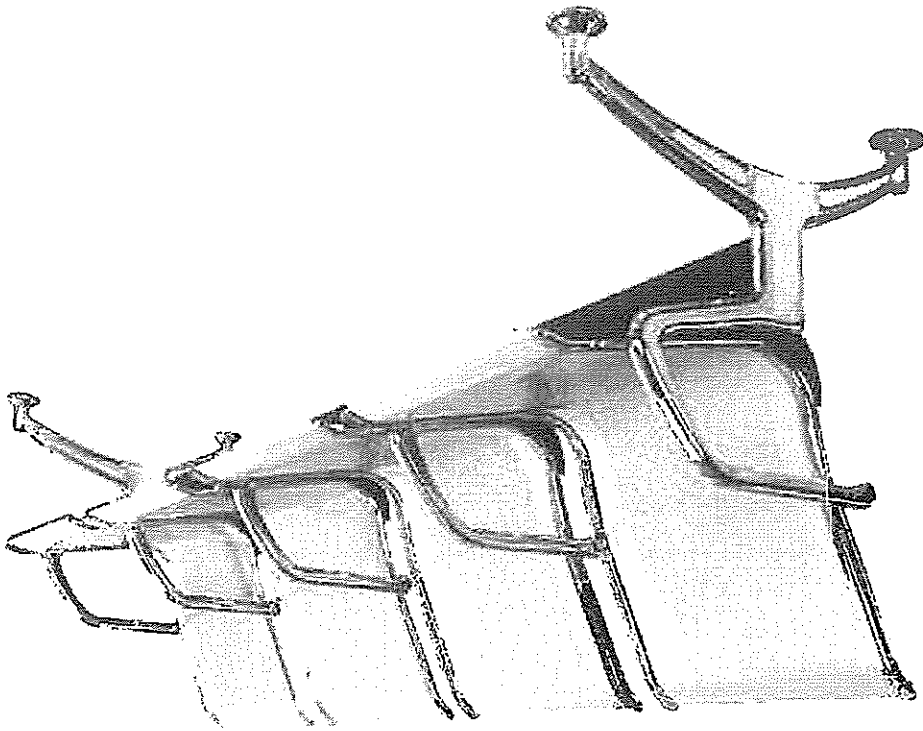

SASSA reception areas, should have: SASSA Vision, Mission and Values prominently displayed; Information Signage of various floors of the building; pictures of political principals. Reception desks should be "C-shaped, semi-circle or L-shaped as indicated above", and in decorative laminate Vancouver Maple 688.

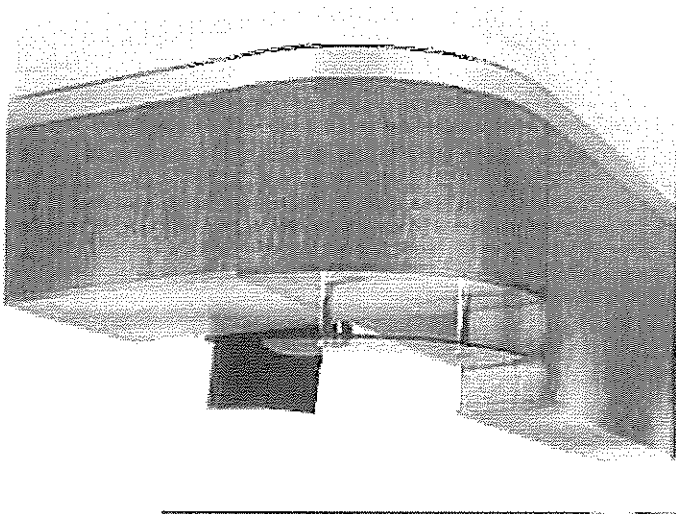

SASSA reception areas which use couches should use black or beige.

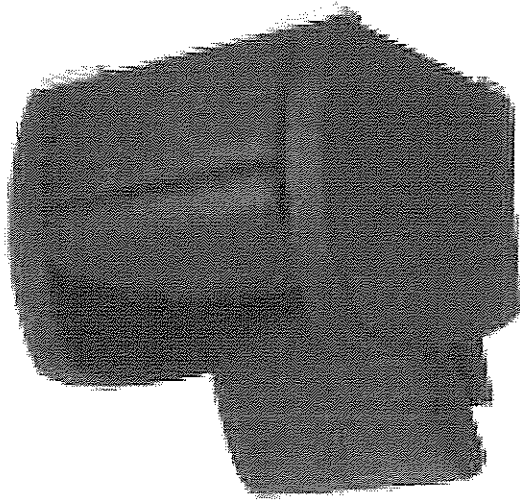

As a service oriented organisation, SASSA provides services where there is constant professional interaction with clients. For this purpose, service cubicles are vital. The cubicles construction, look and feel take cue from the SASSA furnisher with a consistent use of decorative laminated Vancouver Maple 688.

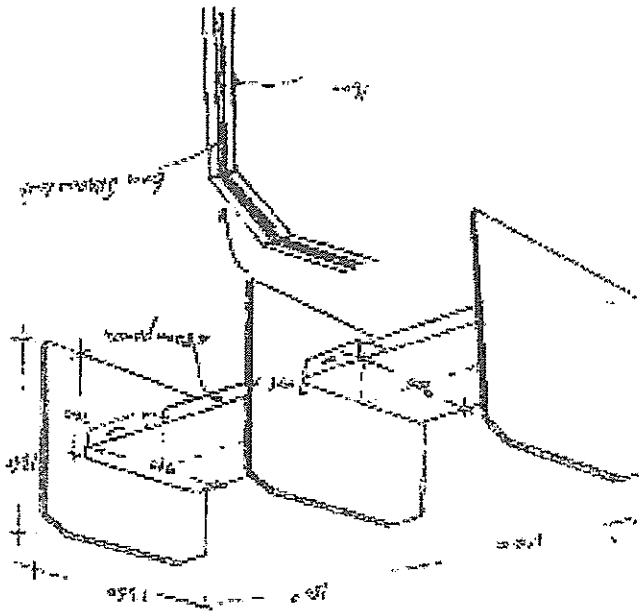

A SASSA Workstation furnisher is a combination of the decorative laminate Vancouver Maple 688 furnisher desk and burnt orange chairs with wheels. The orange is one of the key highlighters within the SASSA corporate colours.

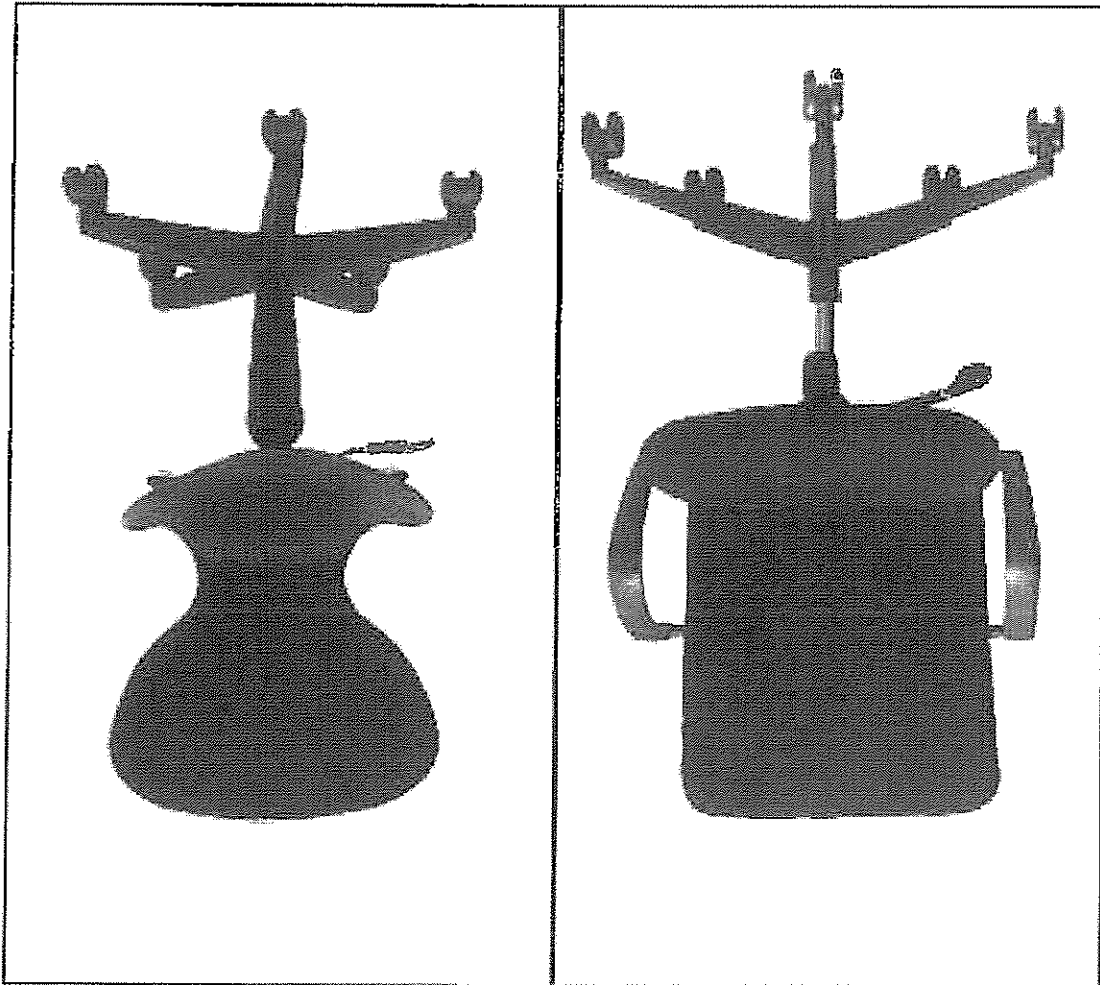

SASSA cluster workstation are decorative laminate Vancouver Maple 688 with silver finishing (where applicable) creates an uncluttered workstation environment

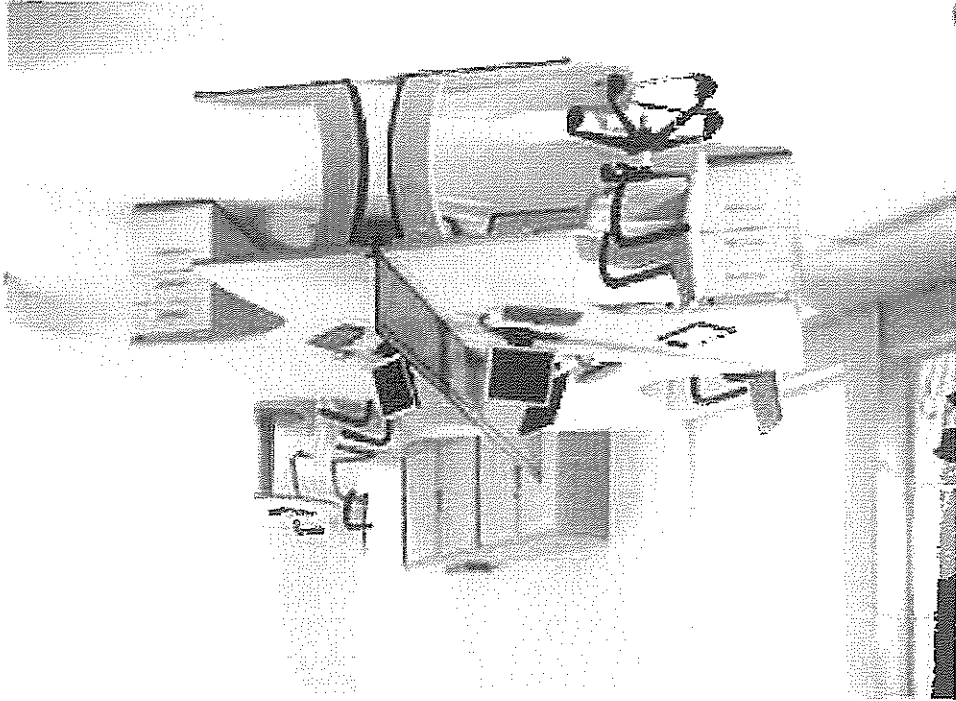

The key feature of the SASSA furnisher is consistent use of decorative laminate Vancouver Maple 688 with quality silver finishes. This creates attractive business environment with a contemporary setting.

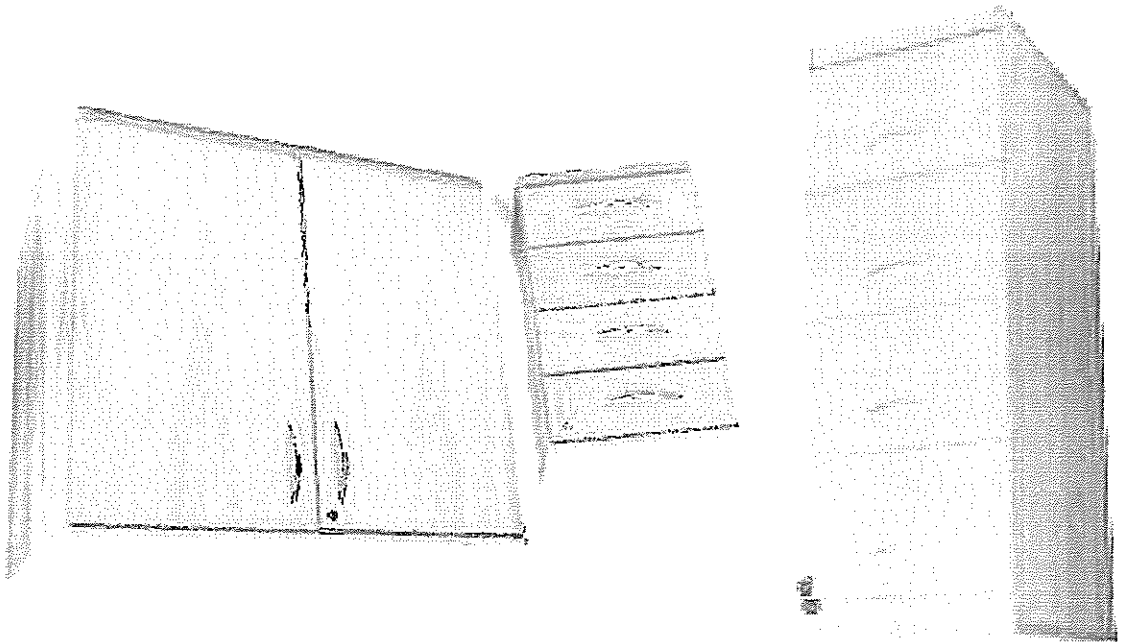
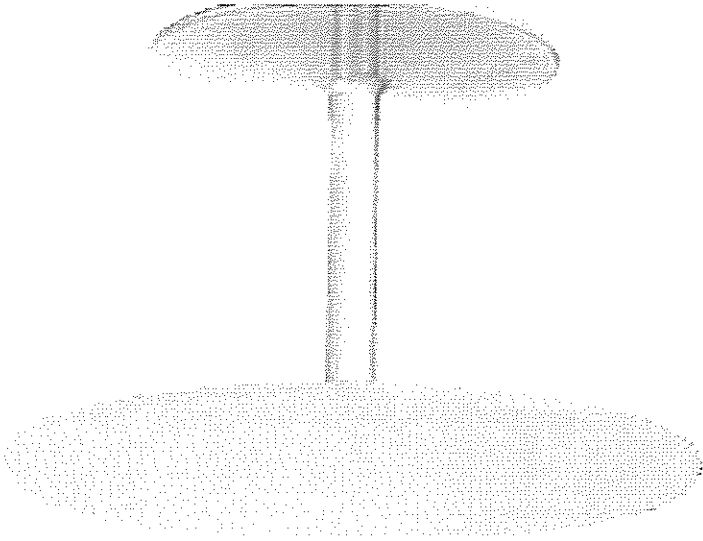

SASSA boardroom table are also decorative laminate Vancouver Maple 588 with silver finishing. In cases where the boardroom table has colour, this will be black. Boardroom chairs should also be black.

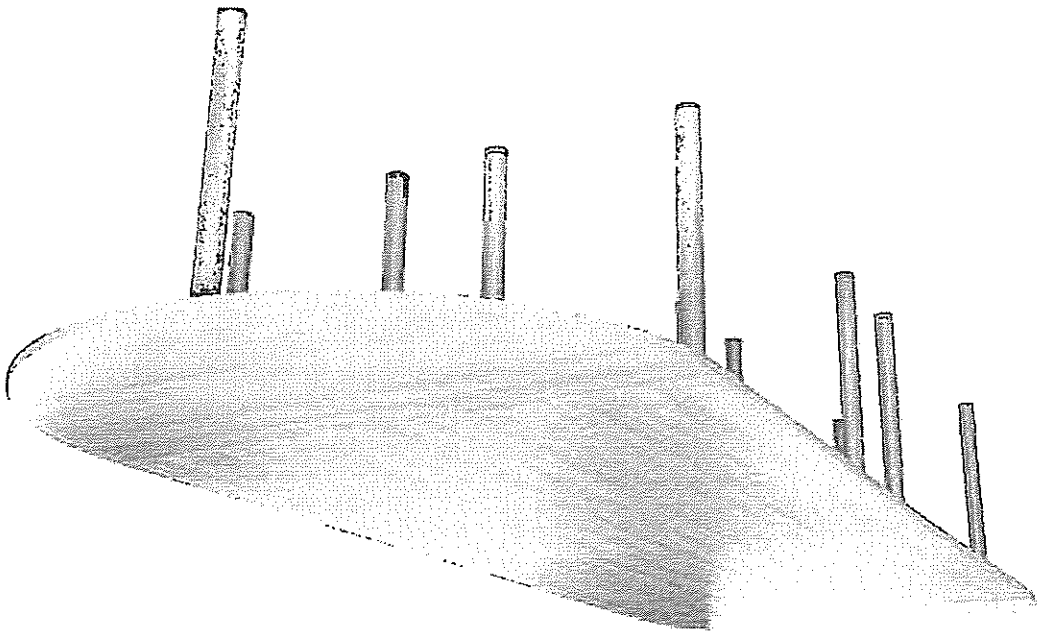

Pause or resting areas will have coloured chairs with the decorative laminate Vancouver Maple 668 table with silver finishing and provide energy through colour. This will be based on the SASSA brand colours. Above all, bright pause areas offer opportunities to revitalise as indicated.

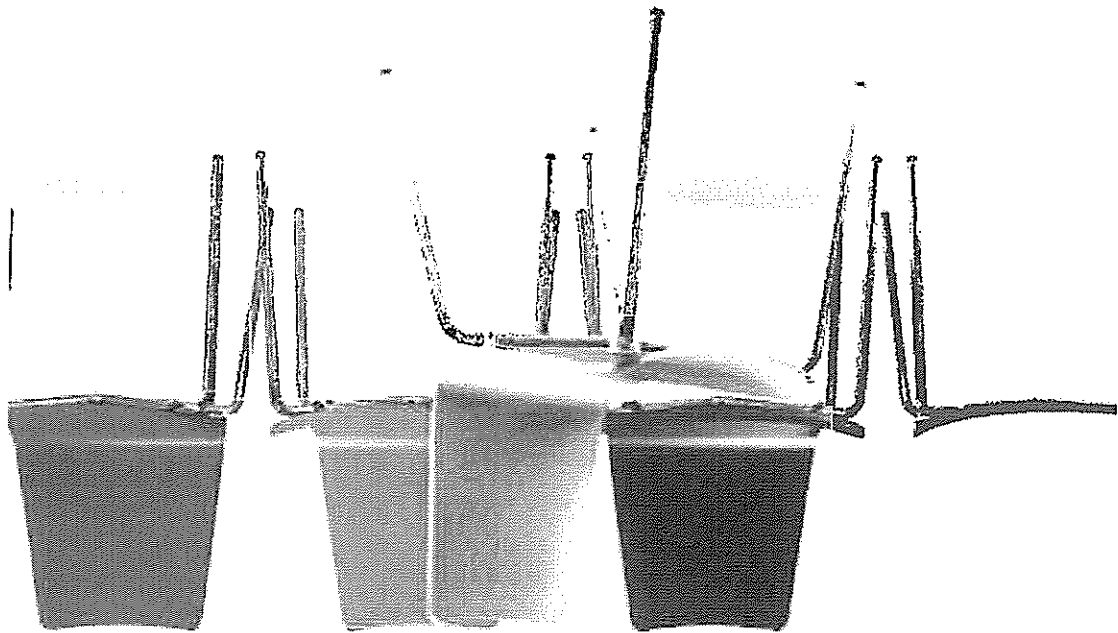

All environmental signage for SASSA should use the horizontal logo (secondary logo) in FULL COLOUR. In cases where the horizontal logo cannot be used or is difficult to use it the SASSA primary logo shall be applied.

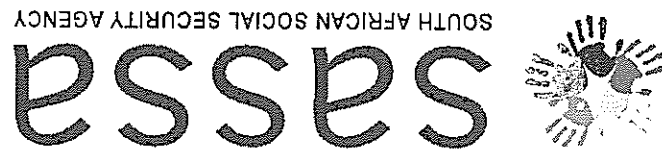

The waste paper bins are designed to be conveniently positioned for staff members & clients. They can either be silver/grey and black.

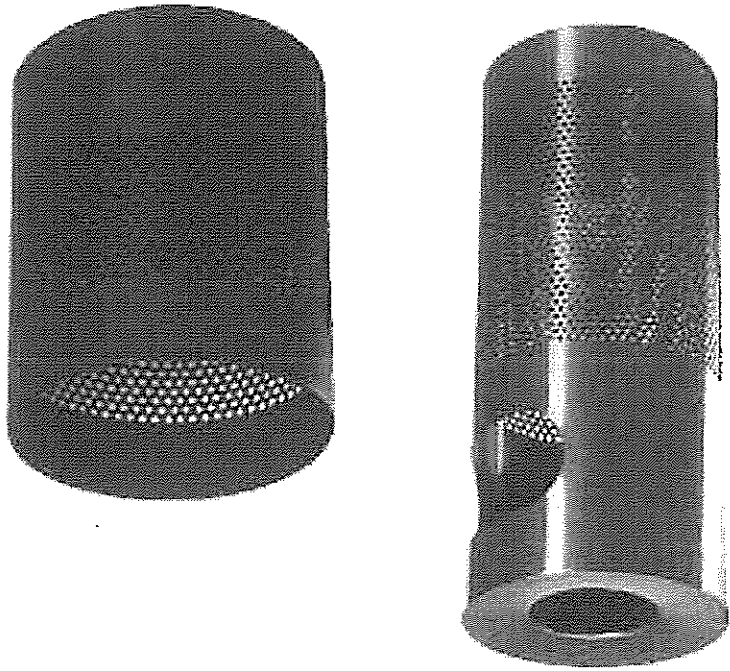

All information of any sign (Identifier, directional or informational) should first be preceded by the SASSA logo on top. There should also be a space between the logo on top and the directions below it. Fonts should be black arial and be visible. Vista systems are recommended in silver or white. *The recommended signs for SASSA signage is Vista System*

Identifier Signage

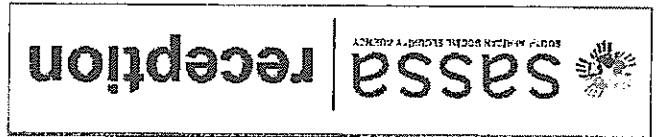

Information Signage

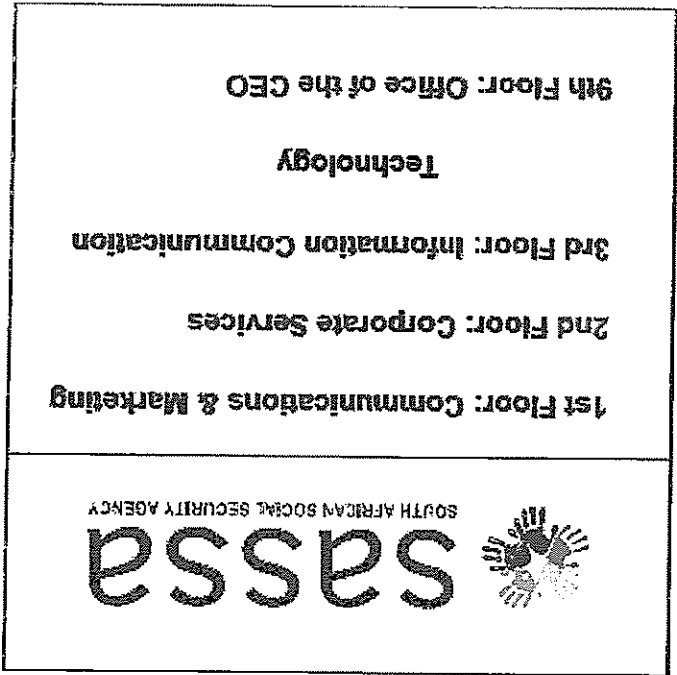

Direction Signage

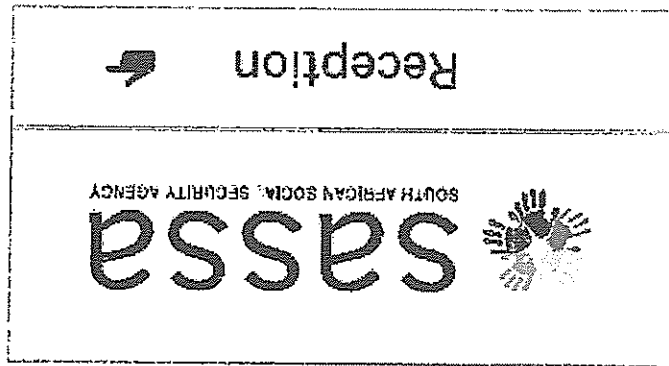

Establish project goal
Determine project scope
Define and understand needs & habits
Clarify functions
Develop time frame & budget

Build project team
Liaise with facilities management
Develop information for design & specifications
Liaise with Senior Manager: Marketing & Publications

Conduct Research
Conduct Site Audit: Building type, local codes, zoning, traffic conditions
Compile Report

Establish project criteria
check: Visibility, Positioning, Safety, Security Maintenance,

Begin design schematic
brand identity collateral
Determine colour, scale, format
Typography
Mounting, and Placement

Develop design
Check envisaged v/s actual
Prepare prototypes
Finalise conten & actual specs
Create drawings or renderings & colour

Complete relevant documents
Finalise specifications
Submit for procurement process
Apply for permission, where necessary

Manage process
Manage and check installation
Inspect work in terms of requirements and specs

The Marketing and Communication Units are responsible for maintenance of the SASA corporate identity. Even so, budget might not necessarily reside in this unit, but when any brand management related activity is undertaken, the marketing and communication unit must form part of the project team and execution.

Regional Marketing and Communication Units

or

For more information contact
Moabi Pitsi
(012) 400 2133
084 300 2242
moabip@sassa.gov.za

FILE NO:

PROPERTY CODE:

CLIENT NAME:

BUILDING NAME AND/OR ADDRESS:

OFFICE AND FUNCTIONAL ACCOMMODATION

FOR

STANDARD LEASE AGREEMENT

DEPARTMENT OF PUBLIC WORKS



Department:
Public Works
REPUBLIC OF SOUTH AFRICA

public works

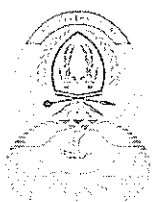

STANDARD LEASE AGREEMENT
FOR OFFICE AND FUNCTIONAL ACCOMMODATION

public works
Department:
Public Works
REPUBLIC OF SOUTH AFRICA



PAGE	HEADING	CLAUSE
4	PARTIES	1
4	DEFINITIONS AND INTERPRETATION	2
8	THE LEASE	3
8	DURATION AND RENEWAL	4
9	THE RENTAL	5
10	USE OF THE PREMISES	6
10	OCCUPATION OF THE PREMISES	7
10	CONDITION OF THE PREMISES AT THE COMMENCEMENT DATE AND AT THE TERMINATION DATE	8
12	FIXTURES	9
12	EXPENSES, MAINTENANCE AND REPAIRS	10
13	OBLIGATIONS OF THE LESSOR	11
15	OBLIGATIONS OF THE LESSEE	12
16	INSURANCE	13
17	FIRE FIGHTING EQUIPMENT AND LIFTS	14
18	ALTERATIONS, ADDITIONS AND IMPROVEMENTS	15
18	DAMAGE TO OR DESTRUCTION OF THE PREMISES	16
19	BREACH	17
20	MANAGEMENT RULES	18
20	LESSORS RIGHT OF ENTRY AND CARRYING OUT OF WORKS	19
21	CESSION, ASSIGNMENT AND SUB-LETTING	20
21	NON-WAIVER	21
22	SALE OF PREMISES	22
23	WHOLE AGREEMENT	23
24	DOMICILIUM CITANDI ET EXECUTANDI	24
25	WARRANTY OF AUTHORITY	25
26	SEVERABILITY	26

INDEX

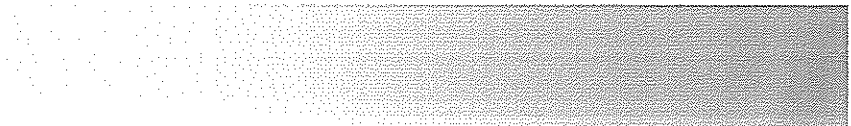

LEASE 1 PARTIES

The parties to this agreement are:

the party identified in item 1.1 of Schedule A (hereinafter referred to as the "lessor");

and DEPARTMENT OF PUBLIC WORKS AND INFRASTRUCTURE

the Government of the Republic of South Africa, herein represented by the Director-General of the Department of Public Works or his/ her duly authorised delegate, (hereinafter referred to as the "lessee").

2 DEFINITIONS AND INTERPRETATION

2.1 In this agreement, unless the context indicates otherwise, the following words have the meaning assigned to them hereunder:

"adjustment date" – means the date referred to in item 8 on Schedule A on which date the escalated rate comes into effect;

"the/this agreement" – means the agreement set out in this document together with Schedule A, Schedule B, Schedule C, Schedule D thereto and any other schedules annexed thereto;

"building" – means the entire structure known by the name as set out in item 2.2 of Schedule A and situated on the property set out in item 2.4 of Schedule A;

"commencement date" – means the date stipulated in item 7 on Schedule A on which date the lease commences;

"commencement rental" – means the rental payable at the commencement of the lease as is stipulated in Schedule B;

"day" – means any day other than a Saturday, Sunday or official public holiday in the Republic of South Africa;

"escalation rate" – means the percentage mentioned in item 9 on Schedule A, which adjusts the rental on every adjustment date;

"expenses" – means those disbursements in respect of the premises which are occasioned by the ownership or the operation thereof, including but not limited to, assessment rates, municipal levies, air-conditioning maintenance, lift maintenance and insurance premiums;

"GCC" – means the General Conditions of Contract, as amended from time to time, issued by the National Treasury of the Government of the Republic of South Africa for purposes of goods and services procurement;

"initial lease period" – means the initial period of the lease, as set out in item 3 of Schedule A;

"lessee" – means the Government of the Republic of South Africa, (herein represented by the Director-General of the Department of Public Works or his duly authorised delegate) its successor-in-title and/or its duly authorised employees, agents, intermediaries, representatives and if and to the extent applicable, shall extend to the invitees;

"lessor" – means the party identified in item 1.1 of Schedule A (herein represented by the person identified in item 1.1.4 of Schedule A who by his/her signature hereto warrants that she/he is authorised to sign this agreement on behalf of the lessor), its successor-in-title and/or its duly authorised employees, agents, intermediaries and/or representatives;

"occupant" – the body defined in item 1.2 of Schedule A, being the body which will physically occupy the premises for the duration of the agreement of the lease;

"party / parties" – means the lessor or any of them as determined by the context;

"premises" – means the building and/or the structure and/or the land, or portions thereof, as set out in item 2.1 of Schedule A and a plan of which is attached as Schedule D, which forms the subject of this agreement;

"repairs" – means everything which is required to be done in order to achieve the same goal as that envisaged in the definition of "maintenance", but which requires more labour and more expense than maintenance, such as the replacement of cables, taps, locks, floor tiles, geysers and the like. The parties are agreed that normal wear and tear can through time require repairs;

"SCC" – means the Special Conditions of Contract, as included in the bid document for the leasing of the premises in question;

"secondary lease period" – means the period mentioned in item 4 of Schedule A, for which this agreement may be extended by the lessor or the lessee from the date on which the initial lease period expires;

"signature date" – means the date of signature of this agreement by the party which signs last in time;

"termination date" – means the date stipulated in item 10 of Schedule A on which the lease terminate, unless extended for the secondary lease period, as more fully detailed in clause 4 hereof;

"VAT" – means Value-Added Tax in terms of the VAT Act; and

"VAT Act" – means the Value-Added Tax Act (No. 89 of 1991), together with all amendments thereto and all regulations published thereunder from time to time;



- 2.2 The clause headings of this agreement have been inserted for reference purposes only and shall not be taken into account in its interpretation. Unless the context indicates otherwise, words importing the singular shall include the plural, words importing persons shall include natural persons and created entities and the state and *vice versa*;
- 2.3 If a provision in a definition is a substantive provision conferring rights or imposing obligations on any party, effect shall be given to it as if it were a substantive provision in the body of the agreement, notwithstanding that it is in the definitions clause.
- 2.4 Any reference to an enactment, regulation, rule or by-law is to that enactment, regulation, rule or by-law as at the signature date, and as amended or replaced from time to time.
- 2.5 Where any number of days is prescribed, such number shall exclude the first and include the last day, unless the last day falls on a Saturday, Sunday or public holiday in the Republic of South Africa, in which case the last day shall be the next succeeding day which is not a Saturday, Sunday or public holiday.
- 2.6 The use of the word "including" followed by a specific examples shall not be construed as limiting the meaning of the general wording succeeding it and the *ejusdem generis* rule shall not be applied in the interpretation of such general wording or such specific examples.
- 2.7 The expiration or termination of this agreement shall not affect those provisions of this agreement which expressly provide that they will operate after any such expiration or termination or which of necessity must continue to have effect after such expiration or termination, notwithstanding the fact that the clauses themselves do not expressly provide this.
- 2.8 In its interpretation, the *contra proferentem* rule of construction shall not apply (this agreement being the product of negotiations between the parties) nor shall this agreement be construed in favour of or against any party by reason of the extent to which any party or its professional advisors participated in the preparation of this agreement.



4.3 The lessee shall give written notice to the lessor of its intention to exercise the option to renew this agreement (referred to in clause 4.2 above) by no later than 3 months prior to the expiry of the initial lease period. Should the lessee fail to so exercise the option and

4.2 Upon the expiry of the initial lease period, the lessee shall have the option of renewing this agreement for an additional period as specified in item 4 of Schedule A as the secondary lease period upon the terms and conditions contained in this agreement provided that in respect of rental payable from the date on which the secondary lease period commences ("the renewal date"), the parties will agree on a market related rental for the premises however the annual escalation rate applicable during the secondary lease period shall be limited to headline inflation or the escalation rate applicable during the initial lease period, whichever is the greater;

4.1 This agreement shall commence on the commencement date and shall endure for the period as specified in item 3 of Schedule A as the initial lease period.

4 DURATION AND RENEWAL

The lessor hereby leases the premises to the lessee who hires the premises on the terms and conditions set out in this agreement, for occupation by the occupant, it being specifically recorded and notwithstanding anything to the contrary contained in this agreement, that the only persons who are mandated to negotiate, enter into, amend or otherwise agree the terms and conditions of this agreement are lessor and lessee provided that any terms and conditions which are specifically exercisable by the occupant in terms of this agreement, shall be so exercisable despite this clause 3.;

3 THE LEASE

2.10 In the event of a conflict between a provision in this agreement and any provision of the GCC, the provisions in the SCC and this agreement shall prevail.

2.9 The provisions of this agreement shall be subject to the provisions of the SCC and GCC, to the extent that such conditions are applicable to this agreement.

- 5.6 The lessee undertakes to pay all VAT, at the standard rate applicable from time to time, leviable on any amounts payable by the lessee in terms of this agreement.
- 5.5 The parties agree that all rentals payable in terms of this agreement shall include VAT where such tax is payable. The lessor shall specify such tax for record and tax purposes separately from the basic rental.
- 5.4 All payments made by the lessee to the lessor in terms of this agreement, shall be effected by electronic payment directly into the lessor's nominated bank account.
- 5.3 The rental shall be paid by the lessee to the lessor, monthly in advance on or before the 7th (seventh) day of each and every month.
- 5.2 The lease commences with the commencement rental. Thereafter the rental shall escalate each year, on each adjustment date, in accordance with the compounded escalation rate as set out in item 9 on Schedule A.
- 5.1 During the initial lease period, with effect from the commencement date, the monthly rental payable by the lessee to the lessor shall be as specified in Schedule B.

5 THE RENTAL

4.4 All extensions to the lease period in this agreement, and any changes to the terms and conditions of lease during such extended period, shall be concluded in writing and signed by the parties prior to the termination date or expiry of any extended period, as the case may be.

the lessee remains in occupation of the premises after the expiry of the initial period or where the option is exercised and the lessee remains in occupation of the premises after expiry of the secondary lease period, this agreement shall continue on a month to month basis on the same terms contained in the Agreement but subject to escalations in the rental until such time as either of the parties gives the other a written notice terminating this agreement, in which event, this agreement shall terminate at the end of the month following the month in which the notice was given.

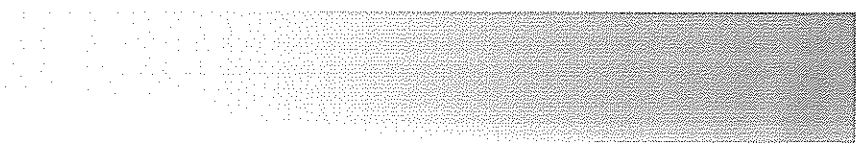

8.1 Schedule C contains details of the installations required by the lessee, the party responsible for effecting those installations and the party who bears the costs in respect thereof. Schedule C also contains the obligations, if any, of the lessee in regard to the

TERMINATION DATE

8 **CONDITION OF THE PREMISES AT THE COMMENCEMENT DATE AND AT THE**

The lessor warrants the lessee's right to free and undisturbed possession of the premises from the commencement date until termination of this agreement, subject thereto that any delay in taking possession due to avoidable actions or omissions of the lessee, shall not be regarded as a delay on the part of the lessor. The date of occupation shall be the date on which the lessee occupies the premises, which shall also be the date of commencement of the lease

7 **OCCUPATION OF THE PREMISES**

6.3 The lessor shall be obliged to obtain such consents and authorisations (excluding trade and other licences) as may be required by competent authorities or title conditions to enable the lessee to use the premises for the purpose referred to in 6.1.

6.2 The lessor hereby warrants and undertakes that the premises are fit for use for the purpose set out in item 5 of Schedule A.

6.1 The lessee records that she/he will use the premises for the purpose specified in item 5 of Schedule A and for any legitimate Government purpose, provided that the lessee shall give the lessor not less than (3) three months' notice of such intent. Where the lessee uses the premises for a purpose other than its intended purpose, the onus shall rest on the lessee to obtain and maintain all necessary permits and/or consents for the use of the premises for that purpose.

6 **USE OF THE PREMISES**

5.7 The lessor shall be liable to pay all rates, taxes, other regulatory amounts and levies in respect of the premises to the relevant authority as well as any expenses and increases.

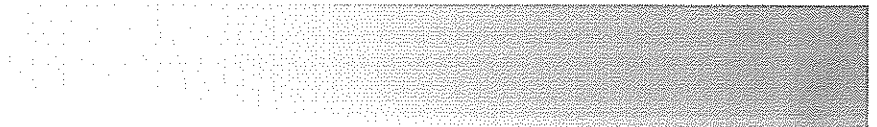

- 8.5.2 A list of the items, which are damaged or defective and which in the opinion of the lessor the lessee is liable for, whereas the lessee denies liability.
- 8.5.1 A list of all the items where the parties agree that such items are damaged or defective and that the lessee is liable; and
- 8.5 The lessor shall furnish dates and times at least fourteen working (14) days prior to the termination of the agreement for the inspection of the premises after termination of the agreement. Within 14 days after the expiry of this agreement, the lessor shall ensure that the following lists are compiled and delivered to the lessee:
- 8.4 The lessor shall within thirty (30) days of such inspection (or such longer period as may be reasonably necessary to repair the defect(s)) repair the defect(s).
- 8.3 The lessee shall, within 30 days of occupation of the premises, furnish the lessor with three (3) dates and times, which dates must be within twenty-one (21) days of occupation, to convene a meeting to inspect the premises. The lessor shall accept a date, from those furnished, that is suitable to him. At such meeting the parties, including the occupant, shall jointly inspect the premises, so as to ascertain any damage or defect in the premises and the general condition of the premises and to record them in a list which all three parties shall sign.
- 8.2 The lessee shall in writing accept that the lessor has complied with terms of the agreement and that the building is ready and available and ready for use.
- removal thereof on termination of this agreement. To the extent that any party does not make the installations listed opposite its name in Schedule C, either of the other parties may have such installations made at the reasonable cost thereof and the party which was responsible for such installation shall become liable for such reasonable amount;



10.1 Subject to 10.3 below, the lessor shall be responsible for and pay all and any expenses in respect of the premises.

10 EXPENSES, MAINTENANCE AND REPAIRS

9.2 the lessor may demand that fixtures which have not been thus removed, shall be removed by the lessee, in which event the same requirements regarding the restoration of the premises 9.1 above shall apply.

9.1 fixtures may be removed by the lessee on condition that the premises are restored to the condition in which they were before the installation of the fixtures, fair wear and tear expected; or

The parties agree that for the purposes of the interpretation of this clause and of this agreement, fixtures shall refer to movable or immovable fittings installed by the lessee and required for its purposes, such as computer cables and telephone systems. The lessee shall be entitled, at its expense and with the written consent of the lessor, which consent shall not be unreasonably withheld (alternatively, as arranged in Schedule C), to install fixtures (which shall remain the property of the lessee) on the premises; provided that, after the termination of this agreement:

9 FIXTURES

8.7 The lessee shall be liable for a pro rata rental in the event the premises/ part of the premises is not available for use.

8.6 The items recorded in the list contemplated in clause 8.5.2 shall be replaced as per agreement between the parties. Should the parties fail to reach such an agreement within seven (7) days from the date of delivery of the lists to the lessee, the dispute may by agreement between the parties be referred to an independent professional who shall act as a mediator in an attempt to resolve the dispute.

responsible for:

In addition to any other obligations contained in this agreement, the lessor shall be

11 OBLIGATIONS OF THE LESSOR

10.5 Should the lessor fail to pay expenses or to undertake repairs for which the lessor is liable in terms of this agreement, the lessee may remind the lessor in writing, and should the lessor still be in default 30 days after receipt of such reminder (or such longer period which the parties may have agreed upon) the lessee shall be entitled to demand specific performance or to pay such expenses or to undertake such repairs (if and to the extent agreed between the parties) and to recover the amounts thus disbursed from the rental due to the lessor by set off (if and to the extent agreed between the parties) or by legal action. A certificate by the lessee of such expenses shall be *prima facie* proof thereof.

10.4 In the event of the premises being a portion of a building and it consequently being necessary to determine the lessee's *pro rata* share in respect of maintenance or consumption of necessary services, the *pro rata* share of the lessee, for the purpose of this agreement, shall be determined by calculating the area of the premises as a fraction of the total area of the building.

10.3 The lessee shall be responsible for and will pay the cost of all electricity, water and/or sewerage consumed on the premises for the duration of this agreement. Electricity and/or water and/or sewerage consumed shall be charged according to the relevant meter reading, provided that the consumption of water, electricity and sewerage in the premises shall be proved *prima facie* by reading of meters or sub-meters and recording same. The lessor shall be responsible for contracting with the suppliers of utilities to the premises referred to in this clause and shall be directly responsible for payment of these charges and any connection fees and deposits in respect thereof.

10.2 The lessor shall be responsible for contracting with the suppliers of utilities to the premises referred to in this clause 10.1 above and shall be directly responsible for payment of these charges and any connection fees and deposits in respect thereof.



for the lessee;

11.10 Water and electricity consumption to the extent that these are not separately metered

during normal office hours or during such times as may be agreed upon;

11.9 Operation (including maintenance and repairs) of the air-conditioning system and the lifts

in a high rise building;

the premises, including the cleaning of the exterior of the premises as well as windows,

11.8 Normal maintenance and repairs (including painting) of both the exterior and interior of

lessee;

premises and shall make good any structural defects, other than damage caused by the

11.7 Maintaining in good order and condition the exterior, roof, gutters and down-pipes of the

therein;

repair of the structure of the buildings, and all systems, works and installations contained

time in or to, the roofs and outside walls of the buildings including the maintenance and

11.6 Maintenance of, and for all repairs and replacements becoming necessary from time to

required in the premises;

11.5 Providing, at the lessor's expense, all electric, fluorescent, and incandescent light bulbs

11.4 Landscape maintenance of the premises, if applicable;

hereof;

detection equipment, fair wear and tear excepted, as further stipulated in clause 14

11.3 Installation and maintenance of mechanical and fire services equipment, including fire

11.2 Insuring the building as provided for in clause 13 below;

11.1 The payment of assessment rates, taxes and fixed municipal levies;



premises;

12.3 Be responsible for all reasonable security, manned or otherwise, necessary to protect the

12.2 Take good and proper care of the interior of the buildings;

than that of the business;

12.1 Not use the premises or allow them to be used, in whole or part, for any purpose other

In addition to any other obligations contained in this agreement, the lessee shall:

12 OBLIGATIONS OF THE LESSEE

necessary and recover the reasonable cost thereof from the lessee.

negligence or willful intent of the lessee, the lessor shall be entitled to attend to the

damages or breakages are attributable to any act or omission of the lessee and/or

available to the lessor in terms of this agreement, where any losses, expenses, costs,

11.17 Quarterly fumigation of the premises. Without prejudice to any rights and/or remedies

of Occupation;

11.16 Compliance with Department of Labour's applicable standards annually – Certification

11.15 Compliance with Occupational Health and Safety and Act (Act No. 85 of 1993);

11.14 Submission of valid annual tax certificate;

in the case of carpeting is 5 years from the date of installation;

11.13 Replacement of floor covering (carpeting etc.) at the expiry of their agreed lifetime which

stipulated in clause 14; and

11.12 Installation and maintenance of the fire extinguishing and fire detection equipment as

11.11 Municipal rates (existing and future) levied on ownership (including rates increases);

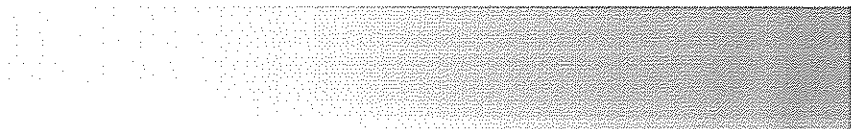

13 INSURANCE

- 12.13 Be responsible for the costs of refuse removal and sanitary services.
- 12.12 Be responsible for the costs of water, electricity and sewerage consumption to the extent that these are separately metered as fully set out in clause 10 above; and
- 12.11 Undertake domestic cleaning of the interior of the premises, including domestic services such as the provision of toilet paper, soap, towels, etc.; excluding common areas;
- 12.10 Forthwith disclose in writing to the lessor details of any act, matter or thing, stored or carried out upon the premises which may affect, vitiate or endanger the fire insurance policy in respect of the property or which may result in an increase of the fire insurance premium;
- 12.9 Not be permitted to place such electrical or other signage on the exterior of the premises without the prior written consent of the lessor;
- 12.8 At all times comply with any law, by-law or regulation of the local authority relating to the conduct of its business at the premises and also with the conditions of the title deed under which the premises are held by the lessor;
- 12.7 Take all reasonable measures to prevent blockages and obstructions from occurring in drains, sewerage pipes and water pipes serving the premises;
- 12.6 Refrain from interfering with the electrical, plumbing, or gas installations or systems serving the premises;
- 12.5 Not unreasonably leave refuse or allow it to accumulate in or about the premises;
- 12.4 Not cause or commit any unreasonable nuisance on the premises or cause any annoyance or discomfort to neighbours or the public;

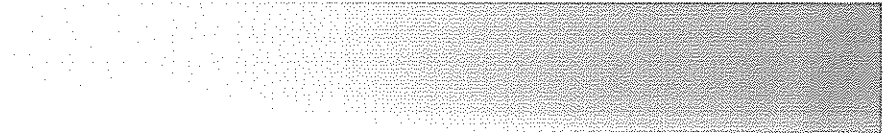

14.1 The lessor shall be obliged to install, maintain and operate on the premises fire extinguishing and fire detection equipment complying with the National Building Regulations and Building Standards Act (Act No. 103 of 1977) as amended, and/or any other applicable legislation.

14 FIRE FIGHTING EQUIPMENT AND LIFTS

13.5 The lessor shall not be liable for any accident, injury or damage incurred by the lessee, his employees, agents or visitors, in or near the premises, unless this could have reasonably been prevented on the part of the lessor.

13.4 The lessor shall not be liable for any damage which the lessee may suffer as a consequence of rain, wind, hail, lightning, fire, earthquake, storm, riots, strikes, actions by enemies of the State or in consequence of the interruption of any facility or service supplies to the premises by third parties, unless such damage could have reasonably been prevented by the lessor.

13.3 Should the lessee knowingly do or cause to be done anything that causes an increase in the premiums of such insurance policy, the lessee will be liable for the increase in the premiums occasioned by the actions of the lessee. The lessor shall furnish to the lessee proof from the insurer of such increase before any payment shall be due from the lessee.

13.2 The lessee and the occupant may not after the commencement of the lease do, or allow anything that is contrary to the provisions of the insurance policy, which will cause an increase in the premiums of any insurance policy held by the lessor over the property, provided that the conditions or the insurance policy will be communicated in writing to the lessee from time to time.

13.1 The lessor shall comprehensively insure the property and the building, and the lessor's fittings at its replacement value, at the lessor's own risk and cost.

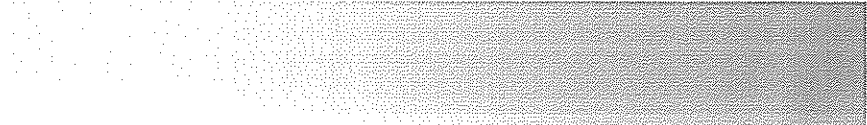

16 DAMAGE TO OR DESTRUCTION OF THE PREMISES

15.2 Notwithstanding the aforesaid, the lessee shall be entitled to make any non-structural alterations or additions to the interior of the premises without the lessor's prior written consent, provided that the lessee may, on the expiration of this agreement, remove such non-structural alterations or additions as it may have made, provided that simultaneously with any such removal, it reinstates the premises or part of the premises in question, at the lessee's cost, to their same condition (fair, wear and tear excepted) as they were in prior to the carrying out of such alterations or additions.

15.1 The lessee shall not make any alterations or additions to any of the buildings, the premises or any part thereof, without the lessor's prior written consent, but the lessor shall not withhold its consent unreasonably to any such alteration or addition. In the event that the lessee does make any such prohibited alterations or additions, it is agreed between the parties that such alterations and/or additions shall be come an immovable part of the respective building or premises to which it is made and shall thus be owned by the lessor who shall not be obliged to compensate the lessee in respect of such alterations and/or additions. Where the lessee has given its prior written consent to any alteration or addition and such alteration or addition has become an immovable part of the building or premises and has added value to the building or premises, the lessor shall not be obliged to compensate the lessee in respect thereof unless otherwise agreed between the parties prior to such alteration or addition being made.

15 ALTERATIONS, ADDITIONS AND IMPROVEMENTS

14.3 The lessor shall provide the lessee with quarterly reports of regular checks done on the fire extinguishers and lifts to ensure safety and security of the occupants of the premises.

14.2 The lessor shall be obliged to maintain the lifts and ensure that regular checks are done in accordance with the Occupational Health and Safety Act (Act No. 85 of 1993) as amended and /or any other applicable legislation.

17.1 Subject to any specific provision in this agreement to the contrary, should:
 17.1.1 the rental or any other amount payable by the lessee in terms of this agreement not be paid by due date or should the lessee commit or suffer or permit the commission of

17 BREACH

16.4 Should there be any dispute as to the extent to which the premises have been damaged and/or the extent to which the premises are unfit for occupation and capable of being used for the purpose for which they are let, the dispute shall be referred to an expert, who shall act as an expert and not as an arbitrator, and whose decision shall be final and binding on the parties. The parties shall jointly agree on who the expert shall be, failing which the expert shall be appointed by the chairperson of the Law Society of South Africa or his delegate.

16.3 Should no notice in terms of 16.2 above be given, then this agreement shall continue and the lessor shall be obliged to proceed expeditiously with the work of rebuilding the premises. Should the parties continue with the agreement, the lessee shall be entitled to a reduction in rental to the extent to which the lessee is deprived of the full and beneficial use and occupation of the premises until such time as the premises have been rebuilt or re-instated provided that the damage or destruction is not due to the willful intent or negligence of the lessee and/or occupant in which case the lessee shall not be entitled to a reduction in rental as contemplated herein and shall remain liable for the full rental.

16.2 In the event of the premises being damaged and remaining partially suitable for the purposes of the lessee, the parties shall be entitled to terminate this agreement by thirty (30) days' notice in writing given to the other party within thirty (30) days after such destruction or damage unless the destruction of the premises is due to the willful intent or negligence of the lessee and/or occupant in which case only the lessor shall be entitled to terminate this agreement as directed above.

16.1 In the event of the premises being destroyed and therefore rendered totally unfit for occupation, this agreement shall be terminated automatically unless the destruction of the premises is due to the willful intent or negligence of the lessee and/or occupant.

The lessor's representatives, agents, servants and contractors may at reasonable times and on reasonable notice (save for the in the event of an emergency), without thereby giving rise to any claim or right of action on the part of the lessee or the occupant of the property or any part thereof, enter the property or any of the buildings in order to inspect them, to carry out any necessary repairs, replacements, or other works, or to perform any other lawful function in the *bona fide* interests of the lessor or the lessee or the occupant, but the lessor shall ensure that this right is exercised with due regard for and a minimum of interference with the beneficial enjoyment of the property by those in occupation thereof, and provided further that such rights will be exercised subject to the lessee's specific security requirements relating to the physical security of the property.

19 LESSORS RIGHT OF ENTRY AND CARRYING OUT OF WORKS

The lessee shall comply with all management rules as may be prescribed by the lessor from time to time provided that they are fair, reasonable and justifiable.

18 MANAGEMENT RULES

17.2 Should either party breach any obligations in terms of this agreement and fail to remedy such breach within 14 (fourteen) days of written demand from the aggrieved party to do so, or such longer period as may be reasonable in the circumstances, the aggrieved party shall be entitled to cancel this agreement or claim specific performance, in either case, without prejudice to the aggrieved party's rights to claim damages from the offending party.

17.1.2 Subject to due process of law, the lessor shall be entitled to claim specific performance, cancel this agreement and retake possession of the premises (without prejudice to any of its other rights under this agreement or at all) and /or claim damages.

any breach of any of the remaining conditions of this agreement and fail to pay such rental or amount or to remedy such breach within 30 (thirty) days after receipt of written notice by the lessor requiring it to do so, or such longer period as may be reasonable in the circumstances; or



22 SALE OF PREMISES

22.1 Transfer of the ownership of premises from the lessor to a third party pursuant to a sale thereof shall not in any way affect the validity of this agreement. It shall accordingly, upon registration of transfer of the premises into the name of the purchaser, remain of full force and effect save that the purchaser shall be substituted as lessor and acquire all rights and be liable to fulfill all the obligations which the lessor, as lessor, enjoyed against or was liable to fulfill in favour of the lessee in terms of this agreement.

21.2 The failure of either party to comply with any non-material provision of this agreement shall not excuse the other parties from performing their obligations hereunder fully and

21 NON-WAIVER

21.1 Neither party shall be regarded as having waived, or been precluded in any way from exercising, any right under or arising from this agreement by reason of such party having at any time granted any extension of time for or having shown any indulgence to the other party with reference to any payment or performance hereunder, or having failed to enforce, or delayed in the enforcement of any right of action against the other party.

20.3 give up possession of the premises or any portion thereof to any third party.

20.2 sublet the premises in whole or in part; or

20.1 cede or assign all or any of the rights and obligations of the lessee under this agreement; or

20 CESSION, ASSIGNMENT AND SUB-LETTING

The lessee shall not, except with the prior written consent of the lessor, which shall not be unreasonably withheld:

24.2.2 is posted by prepaid registered post from an address within the Republic of South Africa to the addressee at the addressee's *domicilium citandi et executandi*, shall be

the contrary is proved;

deemed to have been received by the addressee on the date of the delivery, unless physical address chosen as the addressee's *domicilium citandi et executandi* shall be 24.2.1 is delivered by hand to a responsible person during ordinary business hours at the

24.2 Any notice given by one of the parties to the other ("the addressee") which:

Regions/Provinces).

(and the lessor is explicitly barred from serving such notices on officials and offices in the for the serving of notices the address appearing underneath their names in Schedule A 24.1 The parties respectively choose as *domicilium citandi et executandi* and as the address

24 DOMICILIUM CITANDI ET EXECUTANDI

both parties.

23.3 No variation, alteration, or consensual cancellation of this agreement shall be of any force or effect unless reduced to writing and signed by the duly authorised representatives of

agreement as warranties or undertakings.

23.2 Neither party relies, in entering into this agreement, on any warranties, representations, disclosures or expressions of opinion, which have not been incorporated into this

23.1 This is the entire agreement between the parties.

23 WHOLE AGREEMENT

occupant.

22.2 Nothing shall prevent the lessor from advertising the premises as "for sale" or as "to let" as long as it does not disturb the lessee in its use and enjoyment of the premises and any activities which the lessor undertakes are undertaken on reasonable notice to the



Any provision in this agreement which is or may become illegal, invalid or unenforceable in any jurisdiction affected by this agreement shall, as to such jurisdiction, be ineffective to the extent of such prohibition or unenforceability and shall be treated *pro non scripto* and severed from the balance of this agreement, without invalidating the remaining provisions of this agreement or affecting the validity or enforceability of such provision in any other jurisdiction.

26 SEVERABILITY

The parties hereby warrant that each of them has the power, authority and legal right to sign and perform this agreement and that this agreement has been duly authorised by all necessary actions of its directors, to the extent applicable, and constitutes a valid and binding obligation on it in accordance with the terms thereof.

25 WARRANTY OF AUTHORITY

domicilium citandi et executandi.

24.3 Either party shall be entitled, on 14 days' notice to the other, to change the address of his

24.2.3 is faxed to the chosen fax number, during ordinary business hours shall be presumed to have been received by the addressee at the time of transmission of the fax, alternatively, if not faxed during normal business hours then at twelve o' clock on the 1st business day following the day on which it was faxed.

deemed to have been received by the addressee on the tenth (10th) business day of the date of posting unless the contrary is proved; or

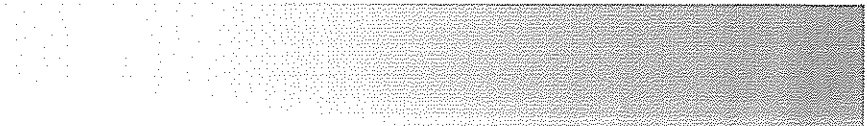

.....
CAPACITY
.....
Duly authorised as per Departmental delegation dated

.....
FULL NAME

.....
SIGNATURE OF LESSEE

1.
FULL NAME AND SIGNATURE
2.
FULL NAME AND SIGNATURE

WITNESSES

SIGNED AT ON THIS THE DAY OF

.....
FULL NAMES
Duly authorised as per attached resolution.

.....
SIGNATURE OF LESSOR / REPRESENTATIVE

1.
FULL NAME AND SIGNATURE
2.
FULL NAME AND SIGNATURE

WITNESSES

SIGNED AT ON THIS THE DAY OF 20.....

**Irregular Expenditure Checklist
Leasing Procurement Strategy**

Transaction Details

Property Description	OPEN TENDER PROCEDURE TO PROCURE AN NEW OFFICE ACCOMODATION FOR SASSA VRENDAL: FOR A PERIOD OF (5) FIVE YEARS: LETTABLE GUIDELINE: 593.75M ² AND 8 PARKING BAYS (UNDER COVER SECURED PARKING BAYS).
Client Department	SASSA
Regional Office	CAPE TOWN
Lease Period Requested	5 YRS
Estimated Amount	R2 409 283.01
Procurement Procedure	OPEN PROCEDURE
Project Manager	ANDISWA FITOLI

Test of Irregular Expenditure (Procurement Strategy)

#	Item	Yes	No	N/A
1	Procurement instruction clearly indicates client needs and period required?			
A.	Letter from the client			
B.	Client Space requirements (CSR)			
C.	(Non-assignable space calculations checked and confirmed)	✓		
	User Specification schedule (USS)			
D.	Preliminary Cost Analysis (PCA) – signed and stamped?			
E.	Annexure A			
F.	Signed Memo			
2	Is the project on the procurement plan (If not, approval to add it on the procurement plan by the delegated authority)	✓		
3	Is BSC approved by the delegated authority? (PA-25.1)		✓	
	(The composition is duly composed in line with SCM policy)			
4	Did BSC members declare their interest? (PA-18.1)	✓		
5	Are the BSC minutes signed by all members and aligned to the procurement strategy?		✓	
6	The completed and signed request for approval of procurement strategy by the Project Leader/Manager is attached? (PA-01)	✓		
7	Goods / services / works will be procured by means of a competitive bidding process (open tender)	✓		
	(If not, proceed to no. 8-9)			

PA-01 (LS): REQUEST FOR APPROVAL OF THE PROCUREMENT STRATEGY

To:	Regional Bid Adjudication Committee
Property description	SASSA: VRENDAL LOCAL OFFICE: OPEN TENDER PROCEDURE TO PROCURE NEW OFFICE ACCOMMODATION FOR A PERIOD OF FIVE (5) YEARS: LETTABLE GUIDELINE: 593,75M² AND 8 PARKING BAYS (UNDER COVER SECURED PARKING BAYS)

Property Manager:	Andiswa Fitolli	Region:	Cape Town
E-mail:	andiswa.ftolli@dpm.gov.za	Cellular phone no:	066 514 3781
Telephone number:	021 402 2326	Fax no:	

1. VALUE THRESHOLD: (Tick only one applicable threshold)

1.1. Estimate Value: R 2 409 283, 01

<input checked="" type="checkbox"/> R1 000 001 – R 50 000 000	<input type="checkbox"/> Above R 50 000 000	<input type="checkbox"/> Below/above 50 000 000
---	---	---

1.2. In case where below/above R 50 000 000 is selected, the lowest acceptable tender will be used to determine the applicable preference point system. (To be used in instances where the estimate cannot be reasonably determined or when one is unsure as to what the market price may be).

1.3. Reason for selecting Below/Above R 50 000 000 option

insert reason including all reasonable steps taken to determine the estimate price (if the provided space is not enough attach a memorandum)

1.4. Net Present Value (NPV): R

2. LEASE PERIOD

2.1. As requested by client (PI) 5 Years

2.2. As recommended by KAM

2.3. Motivation (if 2.2 is different from 2.1)

3. BID / QUOTE CRITERIA:

3.1. The Bid Adjudication Committee's approval is hereby requested for the following procurement procedure:
(If Negotiated Procedure is requested, it must be fully motivated on the PA01.1 (LS) form)

- Open Procedure
- Nominated Procedure
- Quotation Procedure
- Shopping Procedure
- Qualified Procedure
- Proposal Procedure - Two-Stage System

MW



Department of Public Works and Infrastructure
REPUBLIC OF SOUTH AFRICA

Request for approval of the procurement strategy: PA-01 (LS):

4. FUNCTIONALITY CRITERIA APPLICABLE YES NO

Note 1: Failure to meet minimum functionality score will result in the tenderer being disqualified.

Functionality criteria: ¹	Weighting factor:
Total	100 Points

(Weightings will be multiplied by the scores allocated during the evaluation process to arrive at the total functionality points)

Minimum functionality score to qualify for further evaluation: N/A

((Total minimum qualifying score for functionality is 50 percent, any deviation below or above the 50 percent, provide motivation below.

5. APPROVAL IS HEREBY REQUESTED FOR THE FOLLOWING PROCUREMENT PROCEDURE:

Method 1 (Financial offer) Method 2 (Financial and Preference offer)

5.1. Indicate which preference points scoring system is applicable for this bid:

<input checked="" type="checkbox"/> 80/20 Preference points scoring system	<input type="checkbox"/> 90/10 Preference points scoring system	<input type="checkbox"/> Either 80/20 or 90/10 Preference points scoring system
--	---	---

1 The points allocated to each functionality criterion should not be generic but should be determined separately for each tender on a case by case basis.

Any reference to words "Bid" or "Bidder" herein and/or in any other documentation shall be construed to have the same meaning as the words "Tender" or "Tenderer".

MAD



Request for approval of the procurement strategy: PA-01 (LS):

6. RESPONSIVENESS CRITERIA

6.1. Indicate substantive responsiveness criteria applicable for this tender. Failure to comply with the criteria stated hereunder shall result in the tender offer being disqualified from further consideration:

1	<input checked="" type="checkbox"/>	Only those tenderers who satisfy the eligibility criteria stated in the Tender Data may submit tenders.
2	<input checked="" type="checkbox"/>	Tender offer must be properly received on the tender closing date and time specified on the invitation, fully completed either electronically (if issued in electronic format), or by writing legibly in non-erasable ink. (All as per Standard Conditions of Tender).
3	<input checked="" type="checkbox"/>	The (DPW-08 (LS)): Bid offer must be clearly completed by the bidder, with clear specification of the financial offer in terms of rental and tenant installation allowance offered by the bidder. The offer should be submitted as per the bid questionnaire which forms part of the bid documents.
4	<input checked="" type="checkbox"/>	The building must be within the geographic boundaries specified in the bid documents.
5	<input checked="" type="checkbox"/>	Use of correction fluid is prohibited.
6	<input checked="" type="checkbox"/>	Submission of record of attending compulsory virtual bid clarification / site inspection meeting. Clarification of the bid document. During the meeting the bidder and DPW representative must sign the DPW-16 (EC) form as the record of attendance.
7	<input checked="" type="checkbox"/>	An agent may bid on behalf of the owner of the Property but the responsiveness of the bid only measured on the owner/real owner of the property. No points will be given to the Agent unless he/she is buying a property. A copy of the mandate from the owner must be submitted with the bid documents or in case of prospective buyer the signed purchased agreement with a Title deed of the owner must be submitted. Title deed will be required if the tenderer owns the building
8	<input checked="" type="checkbox"/>	The bidder must attach a locality map, e.g., a Google printout. The Department reserves the right to verify the submitted maps. See Annexure A, page 1, paragraph 2.1 of the Special Conditions of the Bid.
9	<input checked="" type="checkbox"/>	The bidder must provide proof of the space required in the form of drawings / floor plans. See Annexure A, page 2, paragraph 2.2 of the Special Conditions of the Bid.
10	<input checked="" type="checkbox"/>	The bidder must submit an approved Town Planning Certificate or Zoning certificate from the Local Municipality confirming the appropriate land use for the requested land. See Annexure A, page 2, paragraph 2.3, of the Special Conditions and the Bid.

6.2. Indicate administrative requirements applicable for this tender. Tenderers may be required to submit the below documents where applicable.

The Employer reserves the right to request further information regarding the undermentioned criteria. Failing to submit further clarification and/or documentation within seven (7) calendar days from request or as specifically indicated, will disqualify the tender offer from further consideration.

1	<input checked="" type="checkbox"/>	Any correction to be initiated by the person authorised to sign the tender documentation as per PA 15.1 or PA 15.2 resolution of boards of directors / or PA15.3 Special Resolution of Consortia or JVs.
2	<input checked="" type="checkbox"/>	Submission of applicable (PA-15.1, PA-15.2, PA-15.3): Resolution by the legal entity, or consortium / joint venture, authorising a dedicated person(s) to sign documents on behalf of the firm / consortium / joint venture.
3	<input checked="" type="checkbox"/>	Submission of (PA-11): Bidder's disclosure.
4	<input checked="" type="checkbox"/>	Submission of (PA 40): Declaration of Designated Groups for Preferential Procurement.
5	<input checked="" type="checkbox"/>	Submission of proof of registration on National Treasury's Central Supplier Database (CSD).
6	<input type="checkbox"/>	Specify other responsiveness criteria
7	<input type="checkbox"/>	Specify other responsiveness criteria
8	<input type="checkbox"/>	Specify other responsiveness criteria

MN

Request for approval of the procurement strategy: PA-01 (LS):

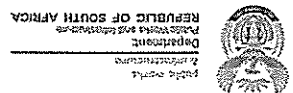

6.3. Indicate administrative requirements applicable for specific goals, Tenderers will not be required to submit the below document if not provided in the original tender proposal, Failure to comply with the criteria stated hereunder shall result in the tenderer not allocated points for specific goals:

1	<input checked="" type="checkbox"/>	Submission of (PA-16): Preference Points Claim Form in terms of the Preferential Procurement Regulations 2022
2	<input checked="" type="checkbox"/>	A trust, consortium or joint venture (including unincorporated consortia and joint ventures) must submit a consolidated B-BBEE Certificate issued by a SANAS accredited service provider

7. COMPLIANCE WITH OBJECTIVE CRITERIA FOR PREFERENTIAL PROCUREMENT
(Applicable to Leasing Services only)

Table 1

<input checked="" type="checkbox"/> Category A	Refers to segment where a property is owned by an enterprise(s) or individual(s) which are not less than. 51% Black ownership 51% Black managed 51% Black controlled and Enterprises in this category, depending on the requirements of the User Department qualify for leases of greater than 5 years.
<input checked="" type="checkbox"/> Category B	Refers to segment where a property is owned by an enterprise(s) or individual(s) which have not less than. 20% Black ownership 20% Black managed 20% Black controlled and Enterprises in this category, qualify for leases of a maximum 5 years.
<input type="checkbox"/> Category C	Refers to segment where a property is owned by an enterprise(s) or individual(s) with less than. 20% Black ownership 20% Black managed 20% Black controlled and Enterprises in this category, qualify for leases of a maximum 3 years.
<input checked="" type="checkbox"/> Category D	Refers to property funds listed on the stock exchange a) That qualify as listed property funds or Real Estate Investment Trusts (REITs) b) That have ownership by black individuals or black enterprises of more than 10% but less than 51% and c) That are managed by property asset management entities with not less than 51% Black ownership, 51% Black Management and 51% Black control. Enterprises in this category, qualify for leases of a maximum 5 years.

MM



Request for approval of the procurement strategy: PA-01 (LS):

8. METHOD TO BE USED TO CALCULATE POINTS FOR SPECIFIC GOALS

Table 2

8.1. For procurement transaction with rand value greater than R1 Million and up to R50 Million (Inclusive of all applicable taxes) the specific goals listed below are applicable.

Serial	Specific Goals	Preference Points Allocated out of 20	Documentation to be submitted by bidders to validate their claim
1.	An EME or QSE or any entity which is at least 51% owned by black people (Mandatory)	10	<ul style="list-style-type: none"> SANAS Accredited BBBEE Certificate or Sworn Affidavit where applicable.
2.	Located in a specific Local Municipality or District Municipality or Metro or Province area for work to be done or services to be rendered in that area (Mandatory)	2	<ul style="list-style-type: none"> Official Municipal Rates Statement which is in the name of the bidder. Or Any account or statement which is in the name of the bidder. Or Permission to Occupy from local chief in case of rural areas (PTO) which is in the name of the bidder. Or Lease Agreement which is in the name of the bidder.
3.	An EME or QSE or any entity which is at least 51% owned by black women (Mandatory)	4	<ul style="list-style-type: none"> SANAS Accredited BBBEE Certificate or Sworn Affidavit where applicable.
4.	An EME or QSE or any entity which is at least 51% owned by black people with disability (Mandatory)	2	<ul style="list-style-type: none"> SANAS Accredited BBBEE Certificate or Sworn Affidavit where applicable. and Medical Certificate indicating that the disability is permanent. Or South African Social Security Agency (SASSA) Registration indicating that the disability is permanent. Or National Council for Persons with Physical Disability in South Africa registration (NCPDPSA).

WML



Request for approval of the procurement strategy: PA-01 (LS):

5.	An EME or QSE or any entity which is at least 51% owned by black youth (Mandatory)	2	• ID Copy and SANAS Accredited BBBEE Certificate or Sworn Affidavit where applicable.
----	--	---	---

8.2. For procurement transaction with rand value greater than R50 Million (inclusive of all applicable taxes) the specific goals listed below are applicable.

NB. The use of one of goal numbers 4 or 5 is mandatory. The BSC must select either one of the two, but not both.

Serial No	Specific Goals	Preference Points Allotted out of 10	Documentation to be submitted by bidders to validate their claim
1.	An EME or QSE or any entity which is at least 51% owned by black people (Mandatory)	4	• SANAS Accredited BBBEE Certificate or Sworn Affidavit where applicable.
2.	Located in a specific Local Municipality or District Municipality or Metro or Province area for work to be done or services to be rendered in that area (Mandatory)	2	• Official Municipal Rates Statement which is in the name of the bidder. Or • Any account or statement which is in the name of the bidder. Or • Permission to Occupy from local chief in case of rural areas (PTO) which is in the name of the bidder. Or • Lease Agreement which is in the name of the bidder.
3.	An EME or QSE or any entity which is at least 51% owned by black women (mandatory)	2	• SANAS Accredited BBBEE Certificate or Sworn Affidavit where applicable.
4. <input type="checkbox"/>	An EME or QSE or any entity which is at least 51% owned by black people with disability (Mandatory)	2	• SANAS Accredited BBBEE Certificate or Sworn Affidavit where applicable. and • Medical Certificate indicating that the disability is permanent. Or • South African Social Security Agency (SASSA) Registration indicating that the disability is permanent. Or National Council for Persons with Physical Disability in South Africa registration (NCPDASA).



Request for approval of the procurement strategy: PA-01 (LS):

	<ul style="list-style-type: none"> ID Copy and SANAS Accredited BBBEE Certificate or Sworn Affidavit where applicable 		An EME or QSE or any entity which is at least 51% owned by black youth (Mandatory) 2	5. <input type="checkbox"/>
--	--	--	--	-----------------------------

9. ADDITIONAL INFORMATION THAT MAY BE REQUIRED DURING THE BID EVALUATION:

Legal Status of Tendering Entity: If the Tendering Entity is: Documentation to be submitted with the tender, or which may be required during the bid evaluation:	a. A close corporation, incorporated prior to 1 May 2011 under the Close Corporations Act, 1984 (Act 69 of 1984, as amended) b. A profit company duly registered as a private company. [including a profit company that meets the criteria for a private company, whose Memorandum of Incorporation states that the company is a personal liability company in terms of Section 8(2)(c) of the Companies Act, 2008 (Act 71 of 2008, as amended)]. c. A profit company duly registered as a private company in which any, or all, shares are held by one or more other close corporation(s) or company (ies) duly registered as profit or non-profit company(ies). d. A profit company duly registered as a public company. e. A non-profit company, incorporated in terms of Section 10 and Schedule 1 of the Companies Act, 2008 (Act 71 of 2008, as amended). f. A natural person, sole proprietor or a Partnership g. A Trust	i. Certificate of Incorporation – CM1; ii. Shareholding Certificates of all Shareholders of the company, plus a signed statement of the company's Auditor, certifying each Shareholder's ownership / shareholding percentage relative to the total; and/or iii. Memorandum of Incorporation in the case of a personal liability company. Copies of: i. Certificate of Incorporation – CM1; ii. Shareholding Certificates of all Shareholders of the company, plus a signed statement of the company's Auditor, certifying each Shareholder's ownership / shareholding percentage relative to the total; and/or iii. Memorandum of Incorporation in the case of a personal liability company.	a. A profit company duly registered as a private company in which any, or all, shares are held by one or more other close corporation(s) or company (ies) duly registered as profit or non-profit company(ies). b. A profit company duly registered as a public company.	e. A non-profit company, incorporated in terms of Section 10 and Schedule 1 of the Companies Act, 2008 (Act 71 of 2008, as amended). f. A natural person, sole proprietor or a Partnership g. A Trust	Deed of Trust duly indicating names of the Trustee(s) and Beneficiary (ies) as well as the purpose of the Trust and the mandate of the Trustees. Copies of: i. the Founding Statement – CK1; and ii. the Memorandum of Incorporation setting out the object of the company, indicating the public benefit, cultural or social activity, or communal or group interest. Copy(ies) of the Identity Document(s) of: i. such natural person/ sole proprietor, or each of the Partners to the Partnership. Deed of Trust duly indicating names of the Trustee(s) and Beneficiary (ies) as well as the purpose of the Trust and the mandate of the Trustees.
--	---	--	---	---	--

10. TENDER ADVERTISEMENT PERIOD:

Value threshold	R1 000 001 and above	<input checked="" type="checkbox"/>
Advertisement period	21 Calendar days	<input type="checkbox"/>
Other: <i>specify if other than 21 calendar days</i>		

MM

11/11

[Handwritten signature]

Confirmation date:		Confirmed available amount:	R2 409 283,01
Contact name:		Tel / Cell no:	
Responsibility:		Objective:	
Note:		Programme:	

16. BUDGET CONFIRMATION (Confirm with financial unit that funds are available for this specific project)

insert comments

15.2 If not, provide approval from the relevant authority
 15.1 If yes, insert Procurement Plan Number 70

15. IS THE PROJECT ON THE DEPARTMENT'S APPROVED PROCUREMENT PLAN? YES

insert comments, e.g. Other specific goals

14. ADDITIONAL COMMENTS: (if applicable)

13. BID DOCUMENTS WILL BE SOLD FOR A NON-REFUNDABLE AMOUNT OF R 200.(IF NOT DOWNLOADED FROM www.etenders.gov.za)

Validity period for procurement strategy is 8 weeks commencing from the date of approval. **NO** extension will be allowed.

12. PROCUREMENT STRATEGY VALIDITY PERIOD

Note: The extension of validity period after bids have been invited may only be approved by the Delegated Authority

Motivate if other than 84 calendar days

Indicator	Value threshold	Validity period
<input checked="" type="checkbox"/>	R1 000 001 and above	84 days Calendar days (12 weeks)
<input type="checkbox"/>	<i>specify if other than 84 days calendar days (12 weeks)</i>	

11. TENDER VALIDITY PERIOD:

Motivate if other than 21 calendar days

Request for approval of the procurement strategy: PA-01 (LS):





Request for approval of the procurement strategy: PA-01 (LS):

17. BID SPECIFICATION COMMITTEE MEMBERS:

17.1 The following members hereby certify that the bid specifications, preference point scoring system and responsiveness criteria have been analysed and have ensured that the specification is not biased.

Bid Specification Committee member:	Signature:	Agreed (Yes/No)	If No indicate reasons (The reasons must also be indicated in the minutes of the meeting)
Project Leader: Andiswa Fitoli		Yes	None
Chair Person: Mathews Nyali		Yes	None
SCM Practitioner: Dora Phooko			
Member: Kabelo Modjela		Yes	H/A
Member: Portia Klaas		Yes	N/A
Member Mothomone Rapudi			

18. COMPILED BY:

PROJECT MANAGER	Signature	Date
Andiswa Fitoli		24/07/2023

19. SUPPORTED BY:

DDG REMS / CD REMS / HEAD OF UNIT	Signature	Date
Ivy Murrudwa		24-07-2023

20. ENDORSED BY:

CHAIRPERSON OF THE BSC	Signature	Date
Mathews Nyali		24/07/2023

21. APPROVED BY:

Approval as per PA12: Approval by National / Regional / Sub Bid Adjudication Committee.



SPECIAL CONDITIONS OF BID

1. DOCUMENTS TO BE SUBMITTED

The following documents should accompany the tender documentation.

- 1.1 Copy of the founding statement (CK1), if the firm is a Close Corporation.
- 1.2 Articles of Agreement, (CM1) and shareholding certificates endorsed by an auditor if the firm is a Company for the bidding entity. If the property offered is held by the holding company which is not the tendering entity, the shareholding certificates of that holding entity must be submitted as well.
- 1.3 Articles of Association and shareholding certificate, endorsed by an auditor, if the firm as a private company (Pty) Ltd. If the property offered is held by the holding company which is not the tendering entity, the shareholding certificates of that holding entity must be submitted as well.
- 1.4 In the event of the bidder being a public company, a letter from their auditor, certifying their status as a public company and attached thereto, a copy of the bidder's Articles of Agreement.

2. BID EVALUATION

The Department and the end user Department will physically verify the property.

- 2.1 **For locality:** The bidder must attach a locality map depicting location of the building or land offered in the CBD of Vredendal.
- 2.2 **For suitability:** the bidder must provide proof of the space required;

The space required is 593,75m² and 8 under cover, safe and secured parking bays for safe and secure Stand-alone building or Multi-tenanted building.

2.2.1 If the parking provided is an off-site parking it should not be more than 100m to 200m from the building.

2.2.2 The building **MUST** be available for occupation by the Department by no later than **four (04) months** after the award of tender and approved space planning . In the case of a vacant site, the building **MUST** be available for occupation by the Department by no later than **Twelve (16) months** after the award of tender (four (4) months to obtain the all necessary approvals from the Municipality and twelve (12) months to complete the construction of the building and to obtain Occupational Certificate).

2.2.3 The building must have a generator or alternative power supply with sufficient capacity to keep it fully operational during power outages/load shedding.

2.2.4 The building must have a water tank with a minimum capacity of 10,000 litres to supply water to the building during water scarcity or outages.

2.2.5 The building must be fully accessible to the disabled and the facilities must be provided as required by the Occupational Health and Safety Act, 1993 (Act 85 of 1993).

2.3 For zoning of the property: The bidder must provide approved Town Planning Certificate or Zoning Certificate from the Local Municipality confirming zoning for commercial / business / offices.

3. BBEE CERTIFICATE

Valid SANAS accredited B-BBEE Certificate or valid Sworn Affidavit to be submitted for this bid must be in terms of the **Property Sector Code and not a Generic Certificate**. Submission of a Generic Certificate will result in the bid not being allocated preference points for specific goals.

4. CLARIFICATION ON PARAGRAPH 5.1 INSPECTION OF THE SPECIFIC GOAL, ITEM NO. 2 OF THE PA04 LS (NOTICE AND INVITATION TO BID

According to the specific goal in paragraph 5.1, item No. 2 of the PA04 LS (Notice and invitation to bid), no preference points will be allocated in the event that the EME or QSE or any Entity is not located in the Specific Local Municipality or District Municipality or Metro area or Province area for work to be done or services to be rendered in that area.

5. INSURANCE CLAIMS, ETC.

5.1 The Department shall not be liable in any manner in respect of any claims, damages, accidents and injuries to persons, property or rights or any other courses of civil or criminal action that may arise from the carrying out of this contract. The landlord shall insure his / her / their personnel and any plant, machinery or other mechanical or electronic equipment involved in the fulfillment of this contract and shall indemnify the Department against all risks or claims which may arise.

6. PRICE ESCALATION

6.1 The escalation rate (percentage) must be market related.

7. DURATION OF CONTRACT

7.1 The contract duration is for a period of five (05) years.

7.2 The Department reserves the right to consider the renewal of the lease, without going to an open bidding process.

8. DISPUTES

8.1 In the event that disputes cannot be resolved by internal systems, the disputes will be settled by means of an arbitration.

9. COMMUNICATION

9.1 The Department of Public Works and Infrastructure will under no circumstances take responsibility if a user department may or might have committed or negotiated with lessors or owners of a building outside its bidding processes.

10. OCCUPATION DATE

10.1 The building MUST be available for occupation by the Department by no later than four (04) months after the award of tender and approved space planning. In the case of a vacant site, the building MUST be available for occupation by the Department by no later than Twelve (16) months after the award of tender (four (4) months to obtain the all necessary approvals from the Municipality and twelve (12) months to complete the construction of the building and to obtain Occupational Certificate).

10.2 Furthermore, a finishing schedule is also required. (Refer to the DPW-11.1 LS form and the minimum technical requirements)

11. COMPLIANCE

11.1 All required building compliance certificates and maintenance contracts shall be issued to the Department 10 (ten) days before hand-over of the building. Non-compliance will lead to cancellation of the award. Certification must include, not limited to the following:
Fire, Electrical, Roof, Institute of Plumbing SA, COC, Building Grade Certificate, Area Certificate or floor plans certified by a professional Architect, as well as air quality certificate, Borehole Beetle test.

11.2 The accommodation must comply with all existing Legislation and Regulations applicable to the Built Environment.

12. PRICE NEGOTIATION

If the price offered by a bidder scoring the highest points is not market related, the Department may not award the contract to that bidder. However,

(a) The Department may -
(i) negotiate a market-related price with the bidder scoring the highest points or cancel the tender;

(ii) if the first highest scoring bidder does not agree to a market-related price, the second highest scoring bidder will be considered or cancel the tender;

(iii) if the second highest bidder does not agree to market-related price the tender shall be cancelled.

(b) If a market-related price is not agreed as envisaged in paragraph (a) (iii), the Department **must** cancel the tender.

13. BUILDING OPERATING COSTS

13.1 The Department will be responsible for the operating costs that relate directly to its own tenancy activities and that, where applicable, are separately metered. The Department is prepared to incur the following operating costs:

- a) Water consumption;
- b) Electricity consumption;
- c) Refuse removal;
- d) Internal security;
- e) Internal cleaning and
- f) Consumable supplies.

13.2 The Department will not be responsible for any other operating costs.

13.3 The Department will not be responsible for the payment of rates and taxes as well as periodic increases thereof.

14. BUILDING MAINTENANCE COSTS

14.1 All maintenance shall be the responsibility of the landlord.

14.2 Other responsibilities between the landlord and the tenant will be stipulated in the lease agreement.

15 PENALTIES

15.1 The landlord shall be liable for any damages to the end user's equipment, machineries and vehicles that may occur as a result of poor or lack of maintenance of the building (e.g damages as a result roof leakages).

15.2 In light of the above (13.1) the landlord shall be responsible for the replacement cost as a result of the said damages.